

Custom
Features
for
1961
Trucks

Custom Features for 1961 TRUCKS

INDEX	PAGES		PAGES
TRUCK AIR CONDITIONER	2-3	CUSTOM FEATURES FOR CORVAN	16-17
CUSTOM FEATURES FOR APPEARANCE	4-5	CUSTOM FEATURES TO COMPLY WITH REGULATIONS	18-19
CUSTOM FEATURES FOR SAFETY	6-7	CUSTOM FEATURES FOR HEAVY TRUCKS	20-21
CUSTOM FEATURES FOR CONVENIENCE	8-9	CUSTOM FEATURES FOR MEDIUM TRUCKS	22-23
CUSTOM FEATURES FOR COMFORT	10-11	CUSTOM FEATURES FOR LIGHT DUTY TRUCKS	24-25
CUSTOM FEATURES FOR RAMPSIDE	12-13	CUSTOM HEATERS AND DEFROSTERS	26
CUSTOM FEATURES FOR LIGHT DUTY FORWARD CAB	14-15	CUSTOM FEATURES FOR PREVENTIVE MAINTENANCE	27

All illustrations and specifications contained in this literature are based on the latest product information available at the time of publication approval. The right is reserved to make changes at any time without notice in prices, materials, equipment, specifications and models, and also to discontinue models.

© 1960
Chevrolet Motor Division
General Motors Corporation

Chevrolet Motor Division
General Motors Corporation
Detroit 2, Michigan

TRUCK
AIR CONDITIONING
for Light,
Medium
and Heavy
Trucks

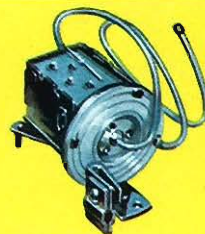

THERMOSTATIC CONTROL

A gas filled capillary tube highly sensitive to heat and cold that cycles the compressor. The control is adjustable and can be set to cycle compressor as required for best operation.

A compact air conditioner that is suspended from the lower edge of the instrument panel to give more leg room in the cab. Trucks equipped with automatic transmission, a center type mounting is used, trucks with gear shift in floor of the cab use a right hand type mounting. Many benefits are derived from an air conditioner system such as clean filtered air free of dust, pollen and moisture. The cool air output capacity is equal to or greater than many window type air conditioners.

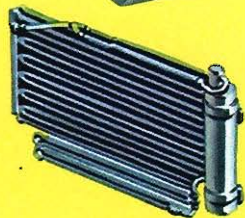
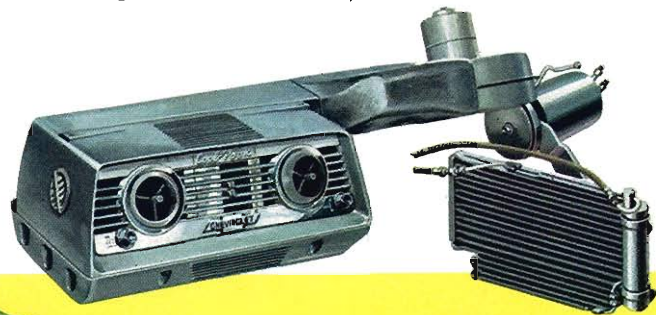

CONDENSER— DEHYDRATOR

All steel tubing for strength. Twin pass tubes for fast heat dissipation. High moisture absorption dehydrator with built-in sight glass.



COMPRESSOR— CLUTCH

A five cylinder axial hermetically sealed Frigidaire ball bearing compressor with an electromagnetic clutch mounted on rubber cushions for quiet long life.

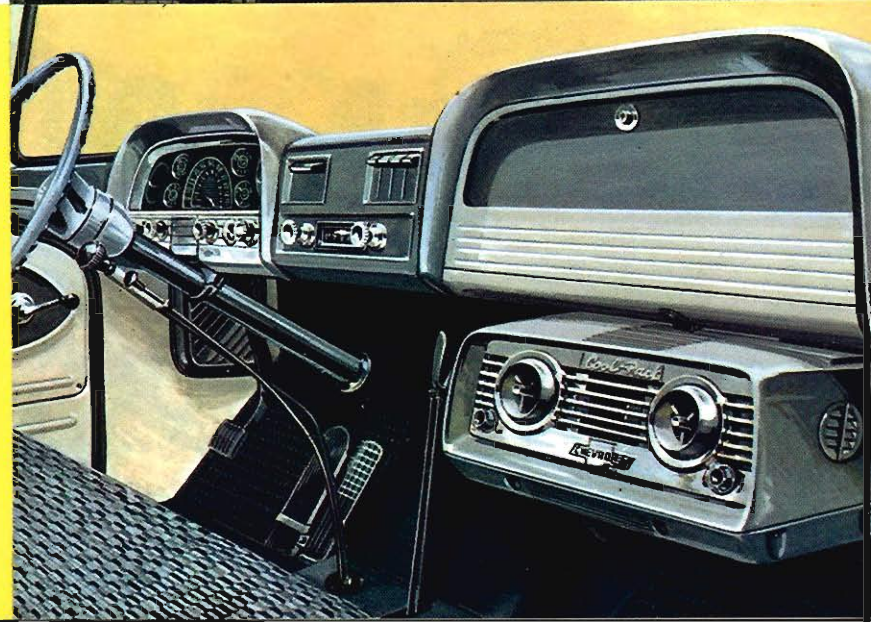
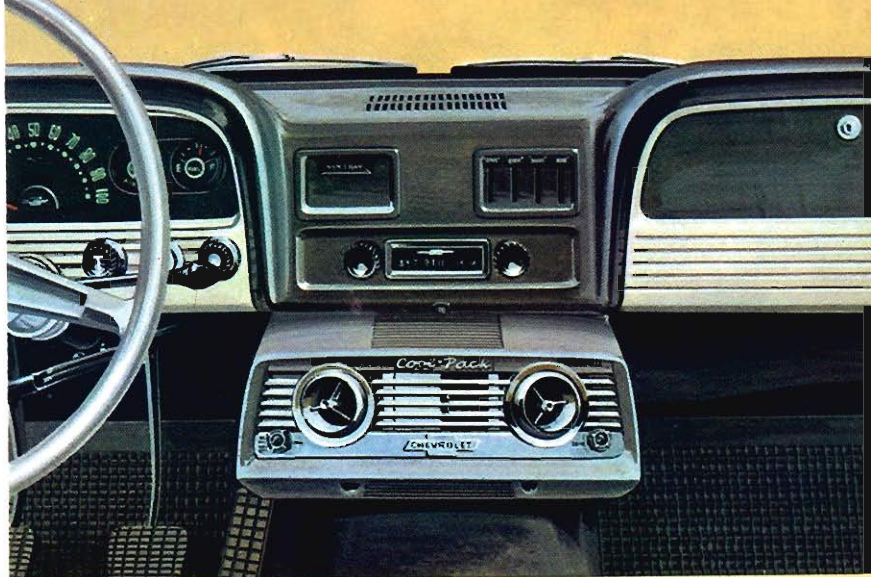

Custom Features for

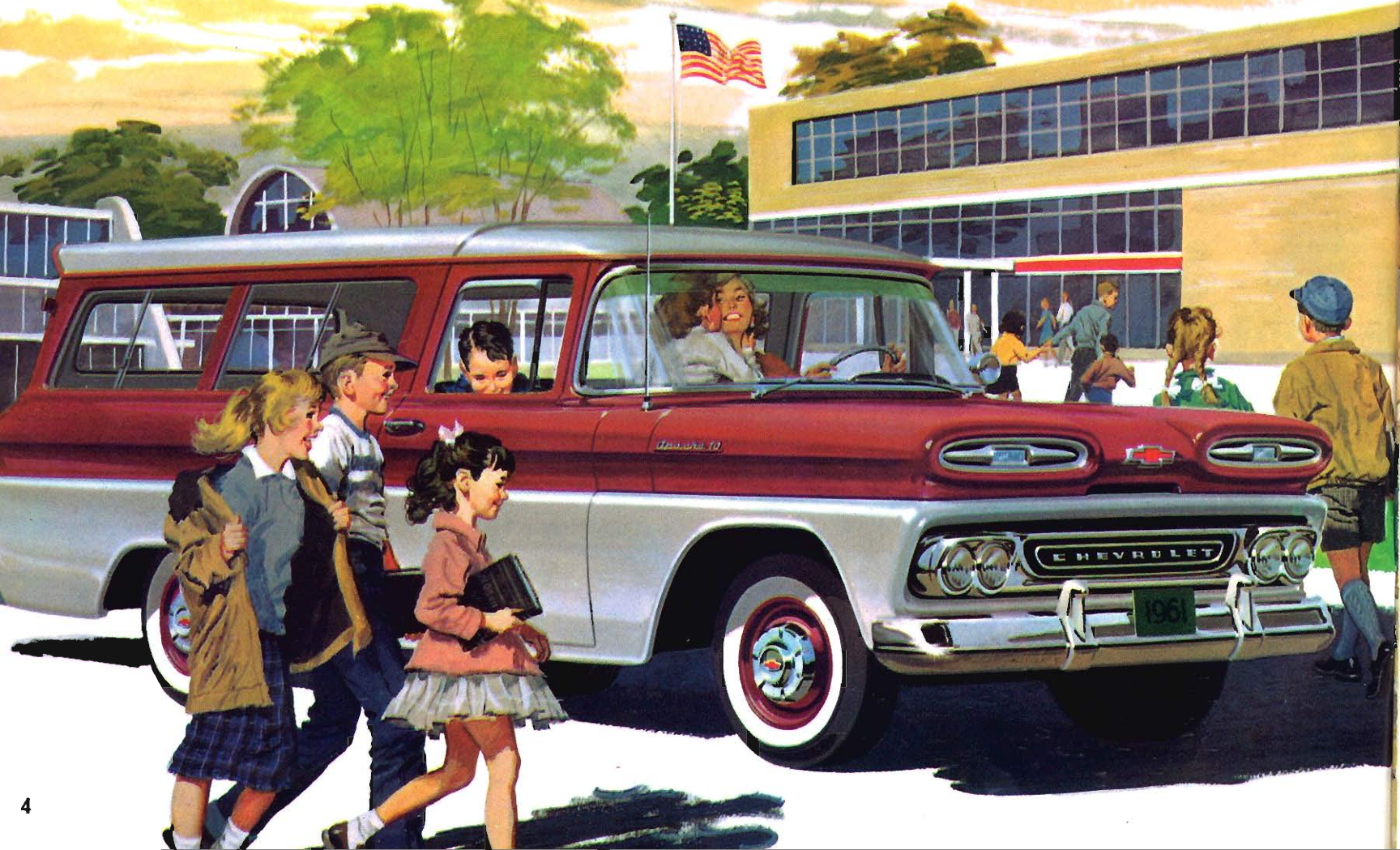

APPEARANCE



CHROME

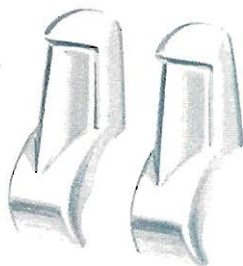

PAINTED

BUMPER GUARDS

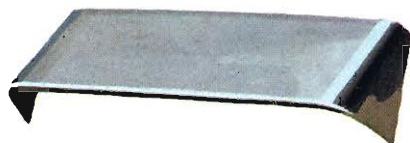

VENTSHADES

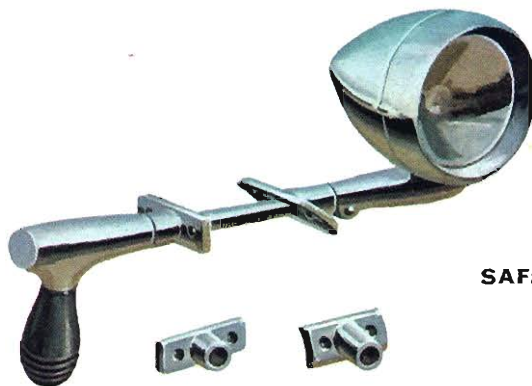

SAFETYLIGHT



ARM REST



**DELUXE OUTSIDE
REAR VIEW MIRROR**



RIGHT HAND SUN VISOR

Custom Features for

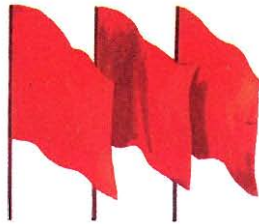

WARNING FLAGS



REFLECTOR FLARES

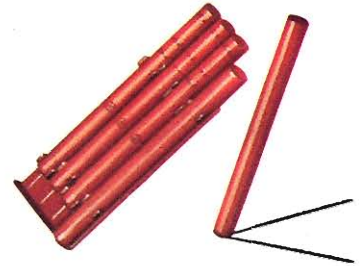

FUSEES AND HOLDER

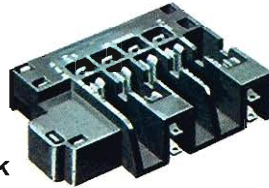

JUNCTION BLOCK



PARKING BRAKE SIGNAL



EMERGENCY AND SAFETY KIT



SPARE BULB CONTAINER

BACK-UP LAMPS

SAFETY



ADV

Custom



Features for **CONVENIENCE**



**RIGHT HAND TAIL
AND STOP LAMP**



ELECTRIC CLOCK

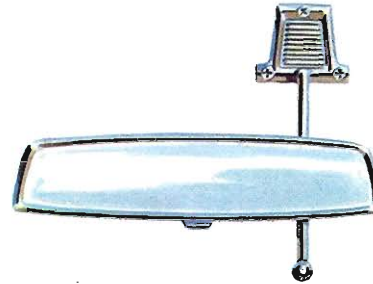

**INSIDE REAR VIEW
NON-GLARE MIRROR**



CIGARETTE LIGHTER



GLOVE COMPARTMENT LAMP



RADIO AND ANTENNA



FIBER SEAT COVER



FLEETSIDE STEP

Custom Features for

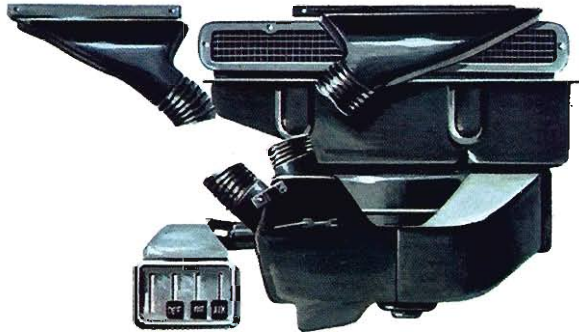

DELUXE HEATER AND DEFROSTER



AIR RIDE CUSHION

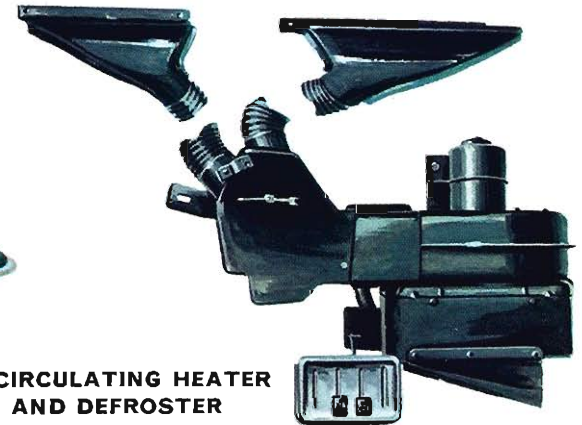

RECIRCULATING HEATER AND DEFROSTER



RIGHT HAND SUN VISOR



CIGARETTE LIGHTER



ARM REST

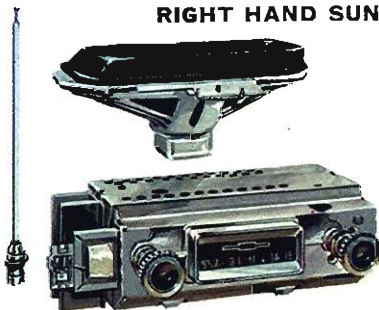

RADIO AND ANTENNA

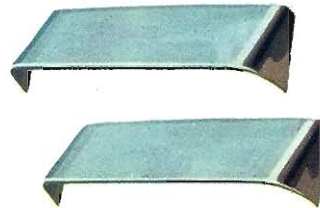

VENTSHADES

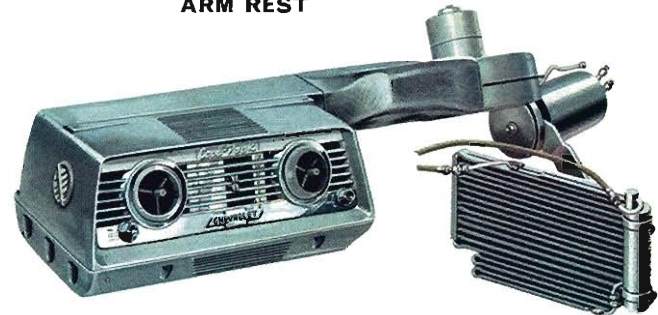

COOL PACK AIR CONDITIONER

COMFORT



Custom Features for



the All New **RAMP**SIDE Pick-up



AIR TO AIR HEATER AND DEFROSTER

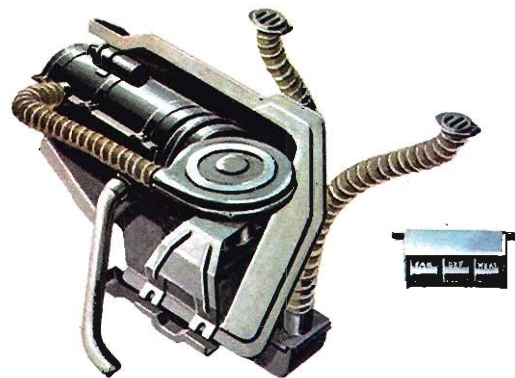

GASOLINE HEATER AND DEFROSTER

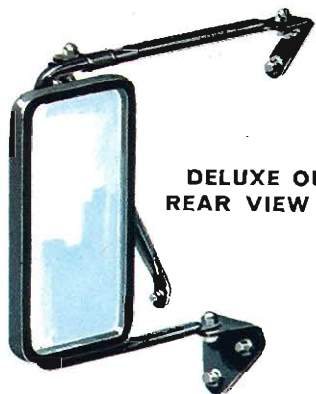

**DELUXE OUTSIDE
REAR VIEW MIRROR**



RIGHT HAND SUN VISOR

**LOCKING GASOLINE
TANK CAP**

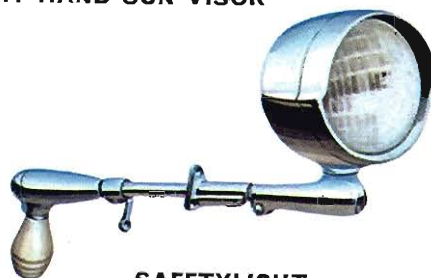
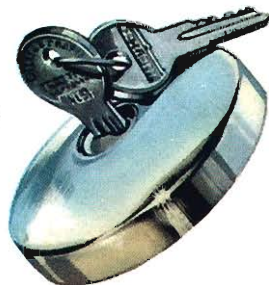

SAFETYLIGHT



HAZARD FLASHER SWITCH

Custom Features for the All New



CHROME

BUMPER GUARDS

PAINTED



PORTABLE HAND SPOTLAMP

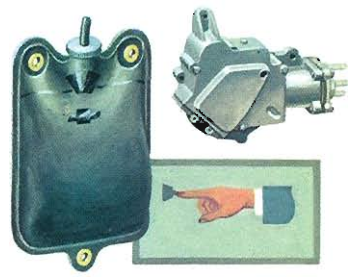

WINDSHIELD WASHER



ARM REST



GLOVE COMPARTMENT LAMP



RADIO AND ANTENNA



CIGARETTE LIGHTER

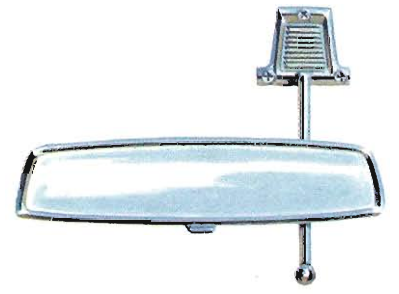

**INSIDE REAR VIEW
NON-GLARE MIRROR**

LIGHT DELIVERY

Forward Cab Pick-up



Custom Features for

Interiors



the All New CORVAN



DOMELAMP



EMERGENCY TOOL KIT



GLOVE COMPARTMENT LIGHT

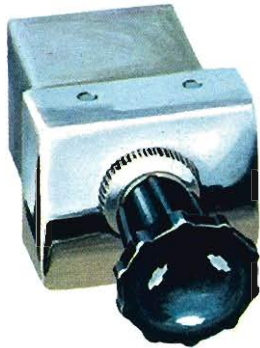

HAZARD FLASHER SWITCH

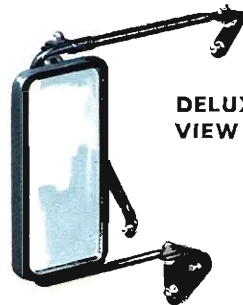

DELUXE REAR VIEW MIRROR



ACCELERATOR PEDAL COVER

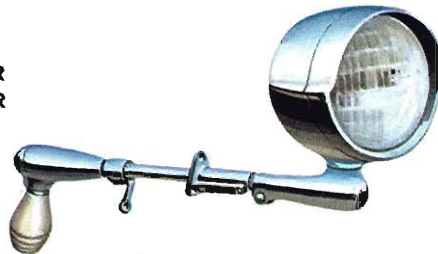

SAFETYLIGHT



SEAT BELTS

CUSTOM FEATURES to Comply with various



SPARE BULB CONTAINER



HAZARD FLASHER SWITCH



WARNING FLAGS

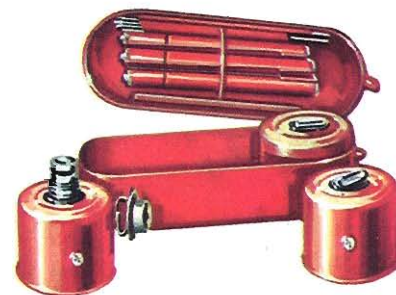

EMERGENCY AND SAFETY KIT

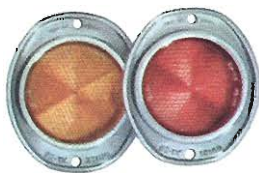

REFLECTORS, AMBER-RED



RIGHT HAND TAIL AND STOP LAMP

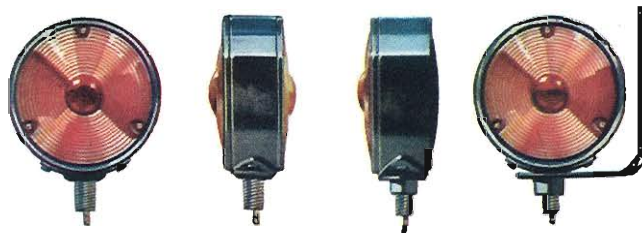

DIRECTION SIGNALS

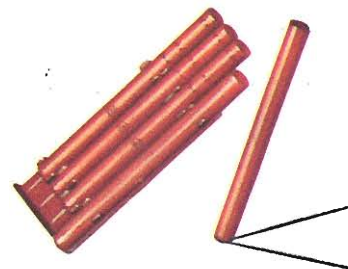

FUSEES

State and Federal Laws



MUD FLAPS AND BRACKETS



CAB CLEARANCE LAMPS

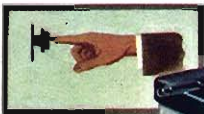

WINDSHIELD WASHER

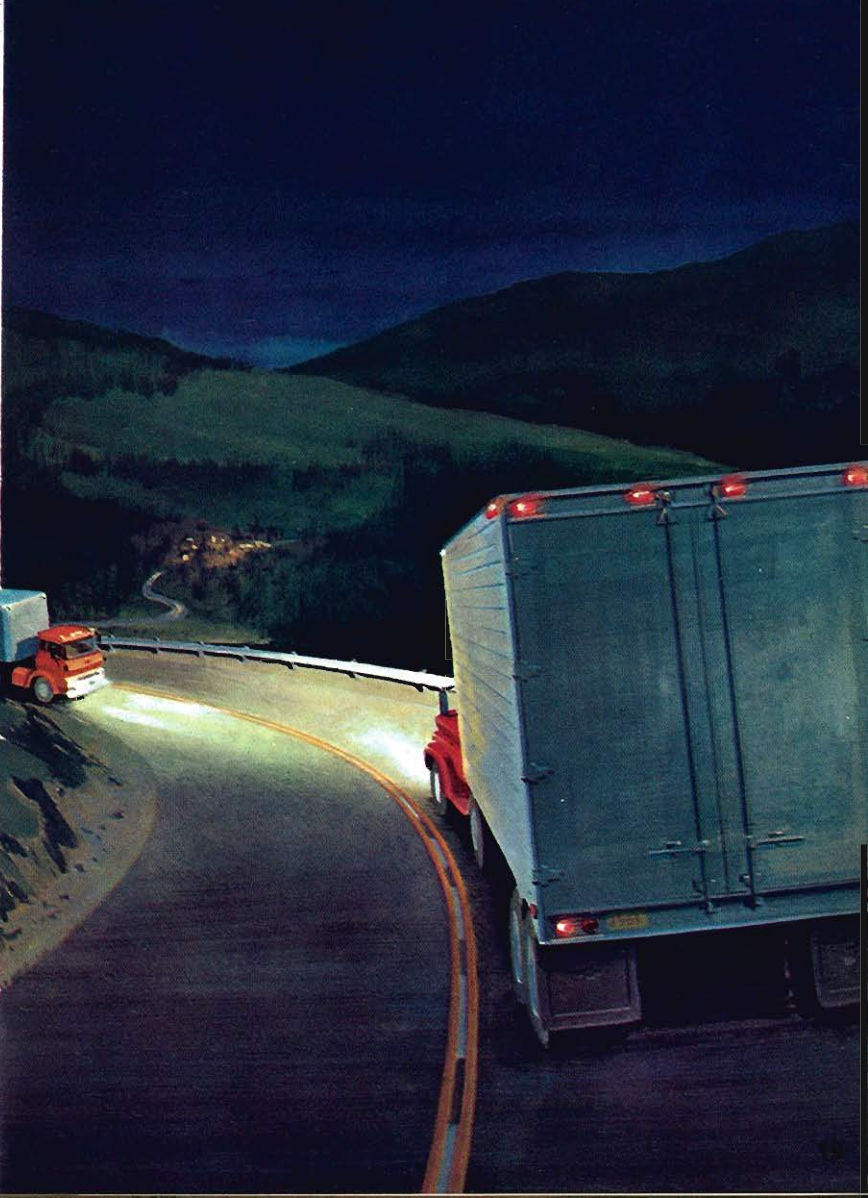

Custom Features



MUD FLAPS AND BRACKETS

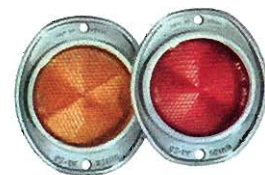

REFLECTORS, AMBER-RED

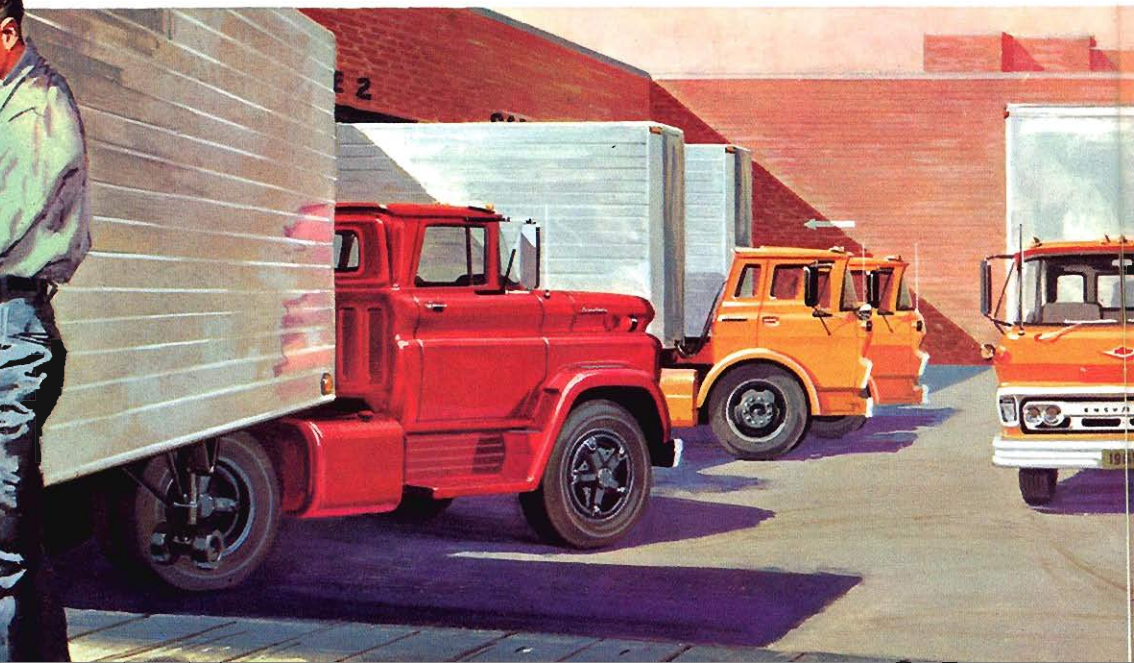

for **HEAVY DUTY** Trucks



AIR HORNS

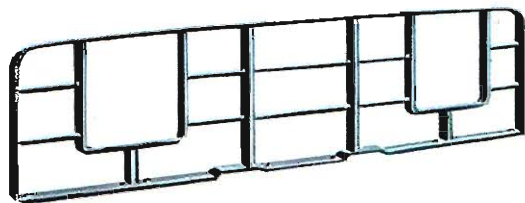

BUMPER GRILLE GUARD

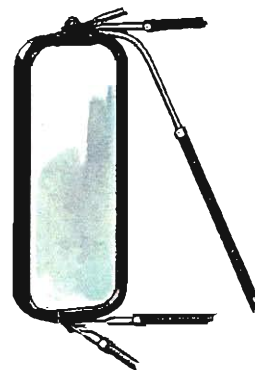

DELUXE RIGHT OR LEFT HAND MIRROR

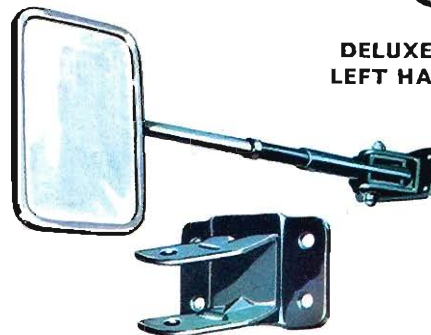

EXTENDABLE RIGHT OR LEFT HAND REAR VIEW MIRROR

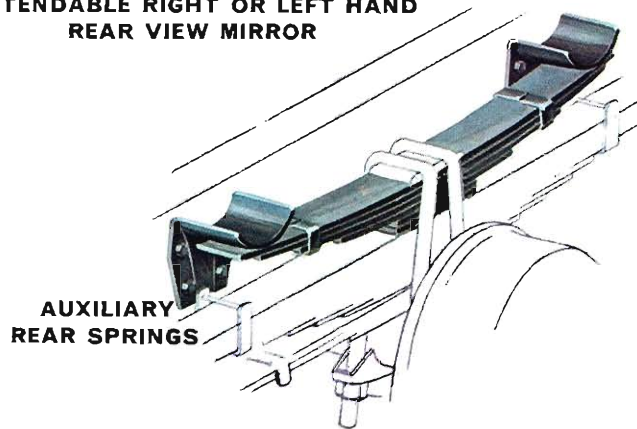
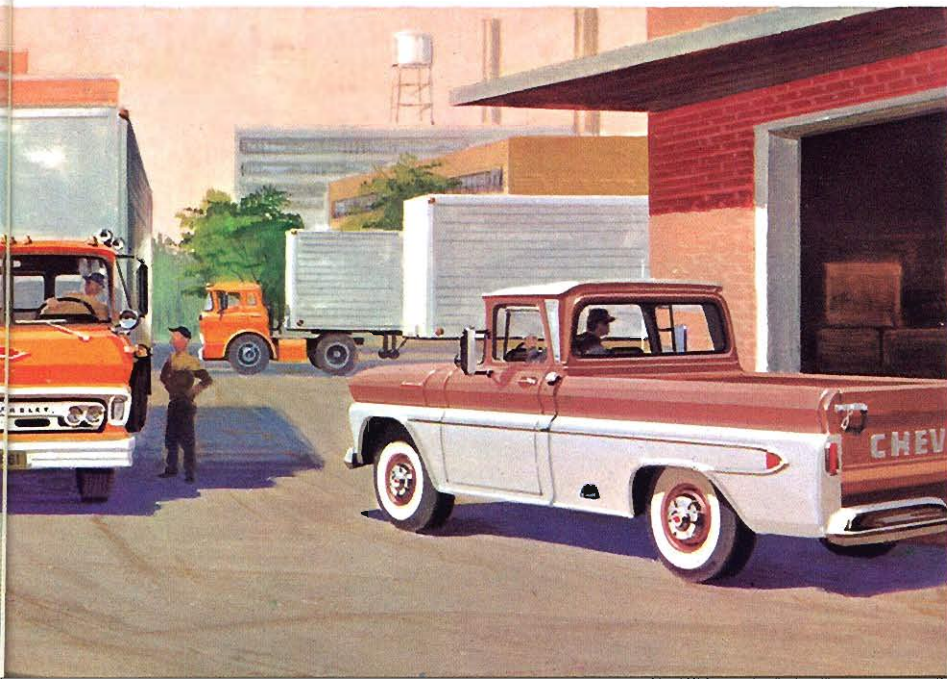

AUXILIARY REAR SPRINGS

Custom Features for **MEDIUM**



MUD FLAPS AND BRACKETS



RIGHT HAND BRACKET

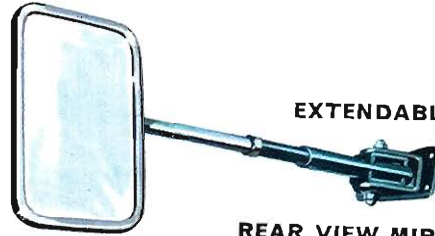

EXTENDABLE

REAR VIEW MIRROR

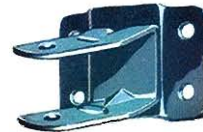

MATCHED HORN

REFLECTOR

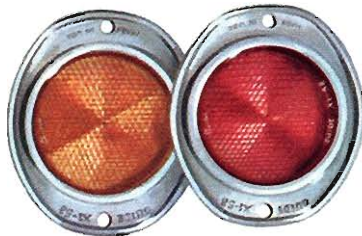

AMBER

RED

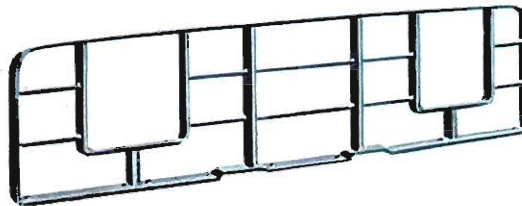

BUMPER GRILLE GUARD

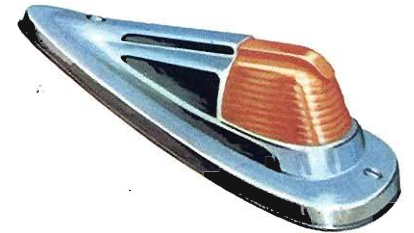

CAB CLEARANCE LAMPS

DUTY Trucks



Custom Features for



LIGHT DUTY Trucks

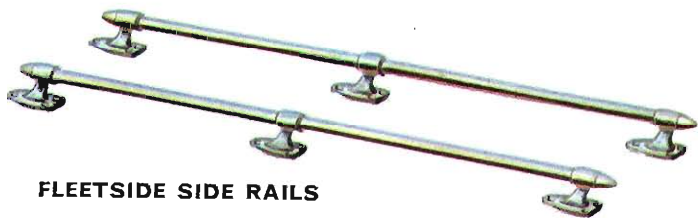

FLEETSIDE SIDE RAILS

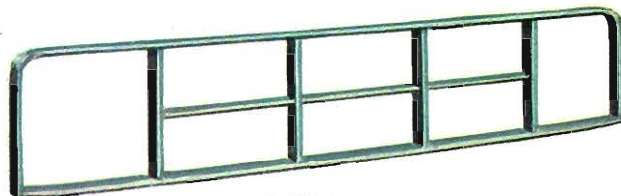

BUMPER GRILLE GUARD



RIGHT HAND SUN VISOR



FIBER SEAT COVER

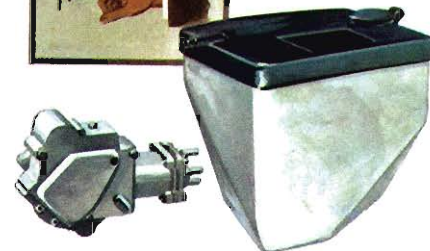

WINDSHIELD WASHER

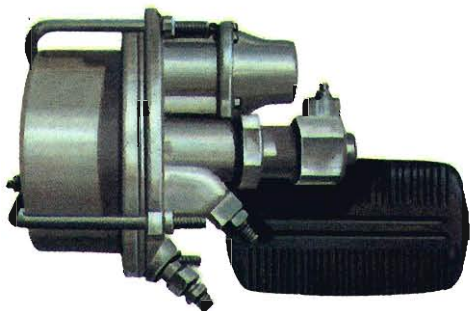

POWER BRAKE



ARM REST

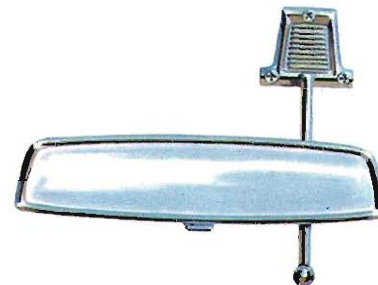

INSIDE REAR VIEW NON-GLARE MIRROR
MIRROR BRACKET

Custom **HEATERS** and **DEFROSTERS**

**DELUXE HEATER
AND DEFROSTER**

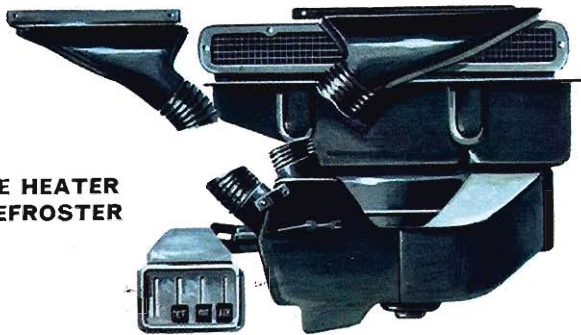

**RECIRCULATING HEATER
AND DEFROSTER**

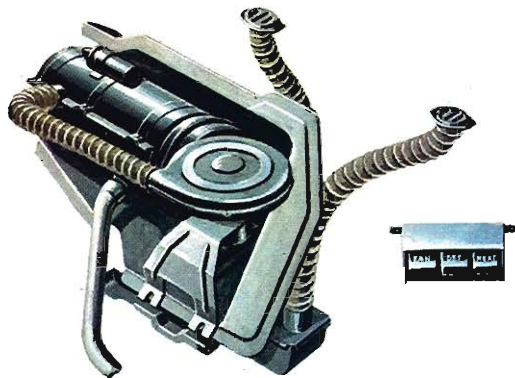
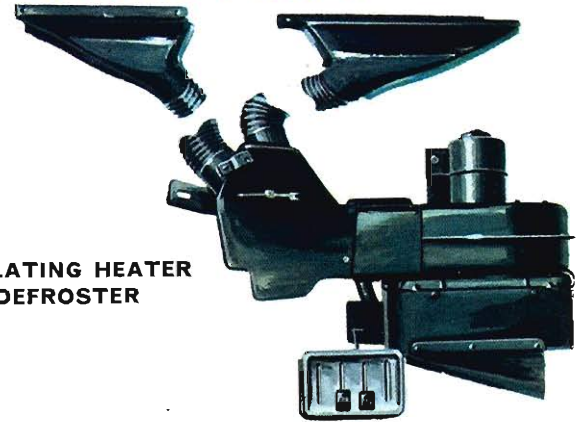

GASOLINE HEATER AND DEFROSTER

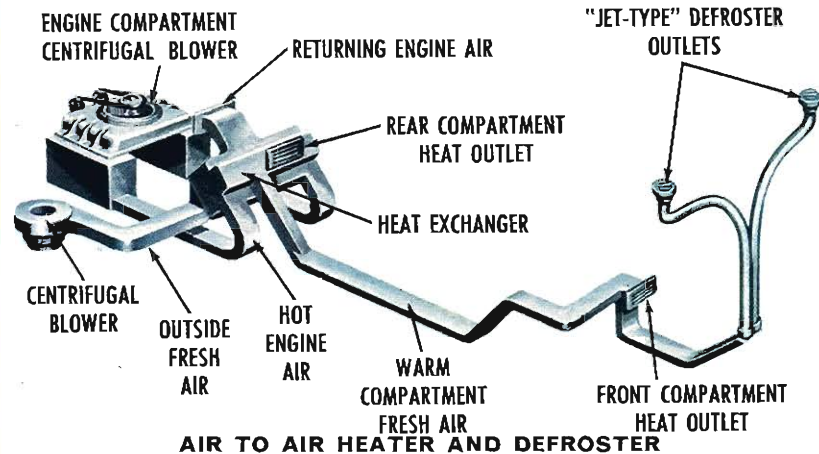

AIR TO AIR HEATER AND DEFROSTER

Custom Features for PREVENTIVE MAINTENANCE



**G. M. ETHYLENE
GLYCOL ANTI-FREEZE**



**G. M. METHANOL
ANTI-FREEZE**



PELLET



LIQUID

RADIATOR STOP LEAK



SPRAY TOUCH-UP PAINT



**RADIATOR RUST AND
CORROSION INHIBITOR**



LUBRIPLATE LUBRICANT



**WINDSHIELD WASHER
ANTI-FREEZE**

1961



Truck Custom Features Parts and Service for New and Used Trucks

AS YOUR FRIENDLY TRUCK DEALER, we are at your service to assist with all your truck requirements. Our staff knows Chevrolet trucks and offers prompt and courteous attention to help you get the best service at the lowest cost per mile from your Chevrolet trucks. We extend a cordial invitation to make our dealership your truck headquarters.

