

# '61

# CHEVROLET TAXI- CABS

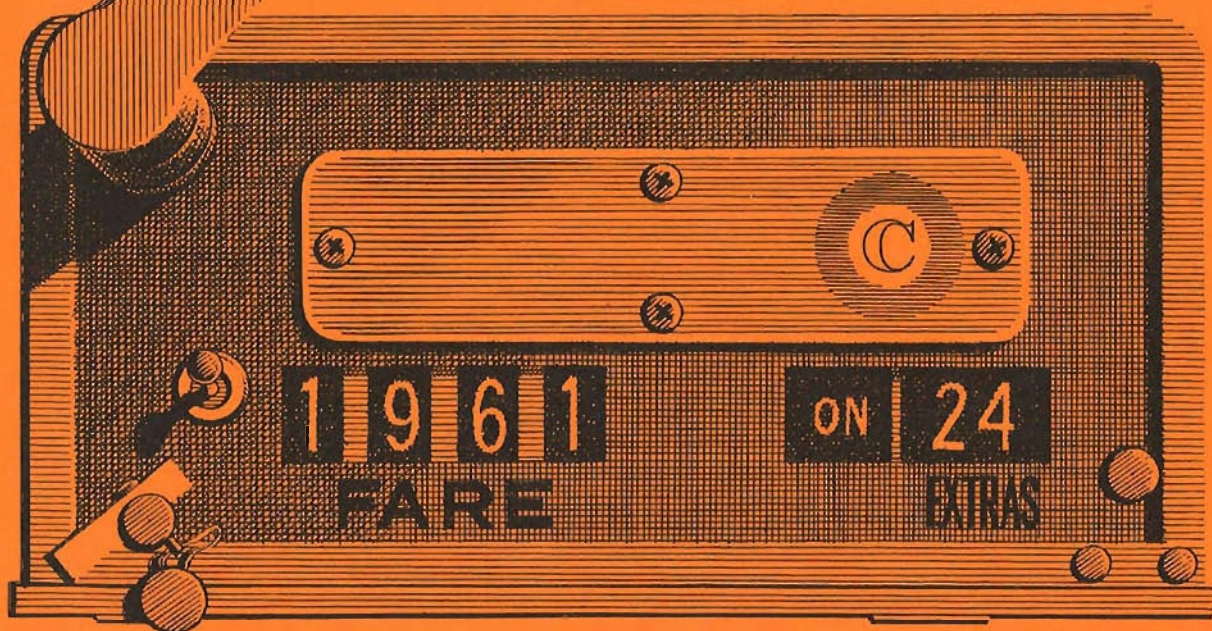

more than ever . . .

# PROFITS

# GO UP!

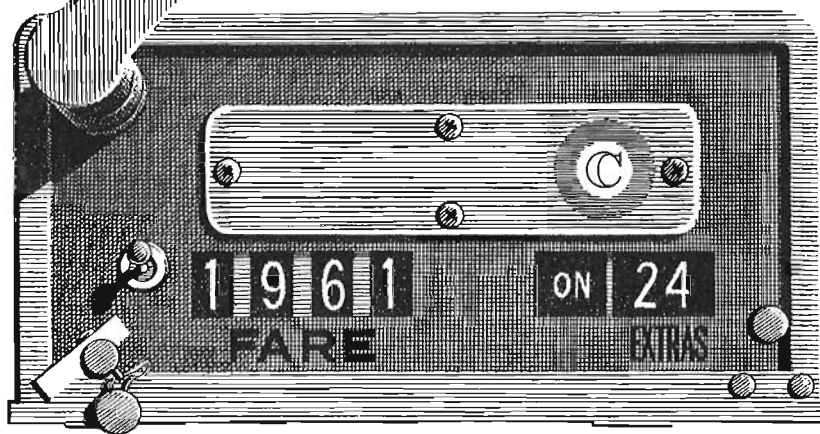

and COSTS GO DOWN with  
**CHEVROLET TAXICABS**

Chevrolet's traditionally low operating cost and high resale value mean more dependable profits in taxicab duty. And for 1961, Chevrolet taxicabs feature new durability, new comfort, new roominess, new convenience, and completely new trunks—all in a trim new size. The 1961 Chevrolet taxicab maneuvers in tight traffic better—and parks in less space. Big new doors open wider, and there's more clearance from the bottom of the door to the ground when they're open.

# BISCAYNE

First-class travel on any trip—that's the Chevrolet Biscayne taxicab for 1961. The smart-looking Biscayne is stylish at any stop—and more practical than ever. Inside, there's a roomy new interior with attractive two-tone upholstery (all-vinyl available at slight extra cost). Wider opening doors plus greater entrance height and comfort-high seats offer new comfort for both driver and passengers. Front door armrests, dual sun visors, and foam cushioned front seat are standard features—other special equipment is available to factory-build your taxicab to your individual specifications.

# BISCAYNE FLEETMASTER

Here's top utility and full-sized economy—at small-sized cost. The Biscayne Fleetmaster taxicab is built with all the traditional ruggedness that has made Chevrolet the world's most popular car. The businesslike Biscayne Fleetmaster is specifically designed for severe taxicab operation. Outside, there's simple trim and ornamentation that makes this model attractive and yet easy to keep clean and new looking. The two-tone interior upholstery is durable vinyl throughout—wipes clean in a hurry. A full line of taxicab-engineered equipment is available at moderate extra cost.



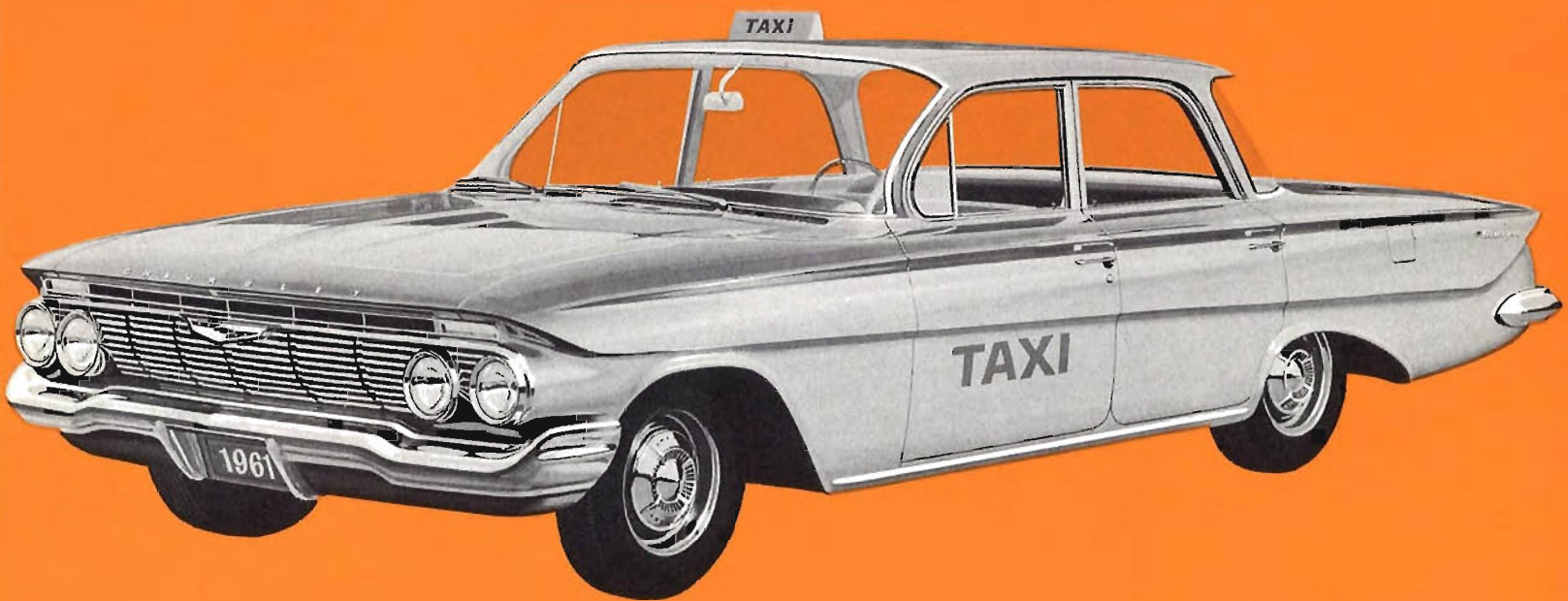



**HEAVY-DUTY REAR AXLE AND WHEEL BEARINGS**

Roller type high-capacity wheel bearings and high torsional rigidity axle shafts, plus stronger suspension mountings, are included for greater durability. (Included in R.P.O. 330\*)

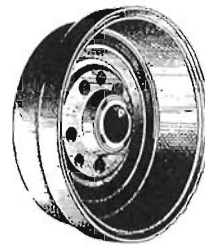

**HEAVY-DUTY FRONT BRAKE DRUMS AND HUBS**

Brake drum webs are extra heavy and wheel hubs are stronger for greater durability in rugged stop-and-go taxicab service. Specially mounted rear brake backing plates and parking brake cable nylon liner are extra-quality features. (Included in R.P.O. 330\*)



**REINFORCED TAXICAB FRAME**

Front crossmember, rear spring and axle reinforcements, plus extra-heavy shock absorber mountings, offer maximum durability under continuous full passenger-load operation. (Included in R.P.O. 330\*)

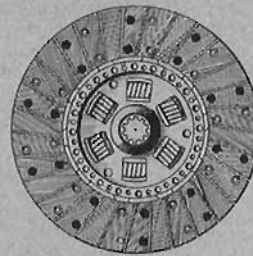

**HEAVY-DUTY CLUTCH (6-cylinder engine)**

Extra-large 11" diameter semi-centrifugal diaphragm spring-type clutch saves down-time in rugged stop-and-go taxicab service. (Included in R.P.O. 330\*)



**HEAVY-DUTY SPRINGS**

Stiffer front and rear coil springs for firmness and ride stability are longer, increasing road clearance approximately one inch, and offer greater load-carrying capacity. (Included in R.P.O. 330\*)

24

FEATURES

THAT MAKE CHEVROLET FACTORY-BUILT TAXICABS LAST LONGER AND EARN MORE

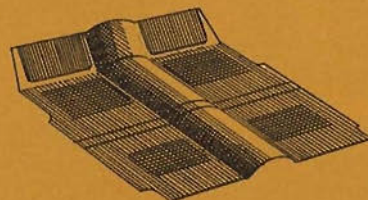

**HEAVY-DUTY FLOOR MATS**

Thick black rubber floor mats, front and rear, feature asphalt-impregnated pad to prevent water-soaking. Front mat includes reinforcement at accelerator pedal. (Included in R.P.O. 330\*)



**SOLID SAFETY PLATE GLASS**

All side windows and rear window feature extra durability to resist cracking in in-and-out, door-opening taxicab service.

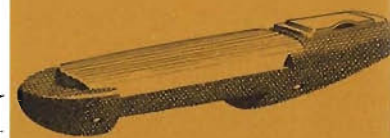

**REAR DOOR ARMRESTS**

Big, door-pull type makes door closing easier, and riding more comfortable. Built-in ashtrays offer extra convenience. (Included in R.P.O. 330\*)



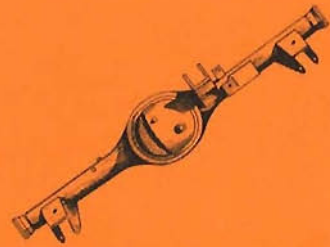

**HEAVY-DUTY REAR AXLE AND WHEEL BEARINGS**

Roller type high-capacity wheel bearings and high torsional rigidity axle shafts, plus stronger suspension mountings, are included for greater durability. (Included in R.P.O. 330\*)

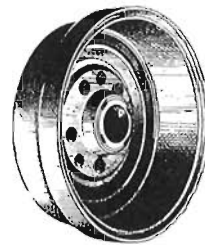

**HEAVY-DUTY FRONT BRAKE DRUMS AND HUBS**

Brake drum webs are extra heavy and wheel hubs are stronger for greater durability in rugged stop-and-go taxicab service. Specially mounted rear brake backing plates and parking brake cable nylon liner are extra-quality features. (Included in R.P.O. 330\*)



**REINFORCED TAXICAB FRAME**

Front crossmember, rear spring and axle reinforcements, plus extra-heavy shock absorber mountings, offer maximum durability under continuous full passenger-load operation. (Included in R.P.O. 330\*)

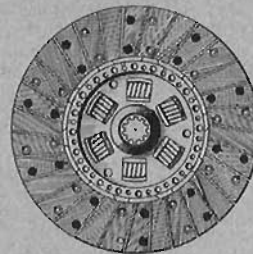

**HEAVY-DUTY CLUTCH (6-cylinder engine)**

Extra-large 11" diameter semi-centrifugal diaphragm spring-type clutch saves down-time in rugged stop-and-go taxicab service. (Included in R.P.O. 330\*)



**HEAVY-DUTY SPRINGS**

Stiffer front and rear coil springs for firmness and ride stability are longer, increasing road clearance approximately one inch, and offer greater load-carrying capacity. (Included in R.P.O. 330\*)

24

FEATURES

THAT MAKE CHEVROLET FACTORY-BUILT TAXICABS LAST LONGER AND EARN MORE

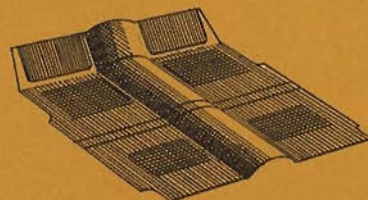

**HEAVY-DUTY FLOOR MATS**

Thick black rubber floor mats, front and rear, feature asphalt-impregnated pad to prevent water-soaking. Front mat includes reinforcement at accelerator pedal. (Included in R.P.O. 330\*)



**SOLID SAFETY PLATE GLASS**

All side windows and rear window feature extra durability to resist cracking in in-and-out, door-opening taxicab service.

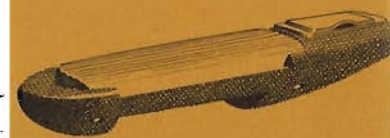

**REAR DOOR ARMRESTS**

Big, door-pull type makes door closing easier, and riding more comfortable. Built-in ashtrays offer extra convenience. (Included in R.P.O. 330\*)





### HEAVY-DUTY REAR SUSPENSION BUSHINGS

Rubber bushings in metal sleeves and specially mounted brackets for rear suspension control arms are designed for rugged street-pounding taxicab operation. (Included in R.P.O. 330\*)



### 15" WHEELS AND TYREX CORD TIRES

Taxi-size 15" wheels and 6.70 x 15 4 ply rating tires have proved more economical in taxicab operation—larger wheels increase road clearance and promote better brake cooling, too. (Included in R.P.O. 330\*)

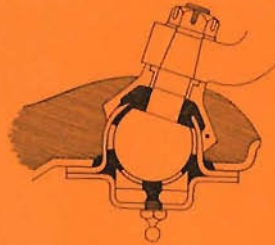

### METALLIC-LINED SPHERICAL JOINTS

Extra-life metal lined spherical joints in front suspension are pre-loaded to maintain constant pressure and insure easy steering—fully sealed to retain lubricant. (Included in R.P.O. 330\*)

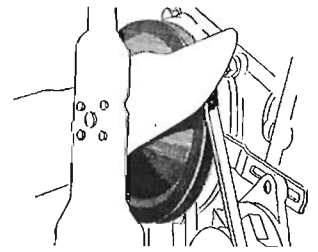

### HEAVY-DUTY WATER PUMP AND FAN PULLEY (6-cylinder engine)

High-capacity water pump with heavy-duty sealed bearings maintains proper coolant temperature under hot-weather driving and idle conditions. (Included in R.P.O. 330\*)

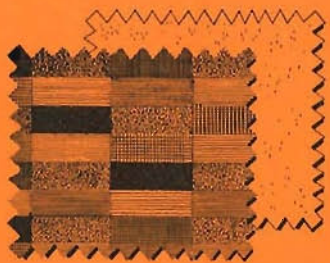

### CHOICE OF INTERIORS

Standard Biscayne interiors are attractive two-tone gray pattern cloth seat upholstery with vinyl sidewall trim and cloth headlining. Biscayne Fleetmaster seats are upholstered in vinyl. All-vinyl Biscayne taxicab interiors for slight extra cost with R.P.O. 330\*.

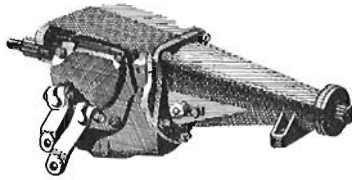

### HEAVY-DUTY TRANSMISSION (6-cylinder engine)

Chevrolet's rugged 3-Speed Synchro-Mesh with all-helical gear design has sturdier mainshaft bearings and clutch driving gear for added transmission durability. (Included in R.P.O. 330\*)

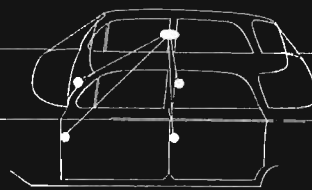

### AUTOMATIC DOOR LIGHT SWITCHES

The interior dome light is automatically controlled by switches in each door pillar. Driver also controls dome light with switch on instrument panel. (Included in R.P.O. 330\*)

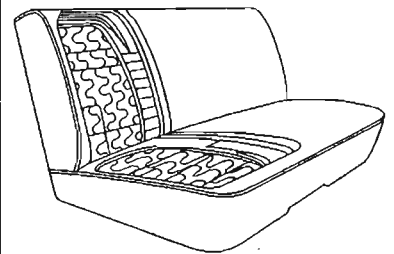

### HEAVY-DUTY REAR SEAT

Taxicab-rugged heavy-duty reinforced spring construction keeps its shape and comfort longer. (Included in R.P.O. 330\*)

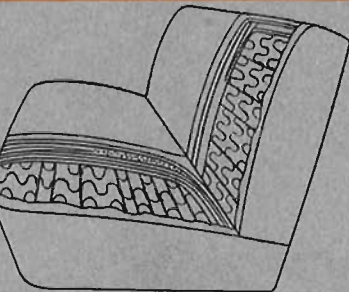

### HEAVY-DUTY FRONT SEAT

Reinforced heavy-gauge S-wire springs in seat cushion and backrest resist sagging for longer-lasting comfort and good looks. (Included in R.P.O. 330\*)



### HEAVY-DUTY SHOCK ABSORBERS

Special valving for firmer control over all road surfaces increases durability and passenger comfort especially when the cab is fully loaded. (Included in R.P.O. 330\*)

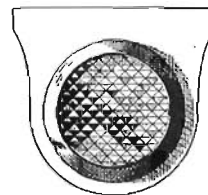

### OPEN-DOOR WARNING LIGHT

Red light on instrument panel warns driver when any door is open and contributes to safety of driver and passengers. (Included in R.P.O. 330\*)

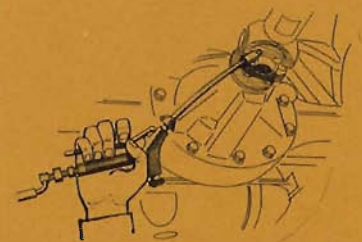

### DRIVESHAFT LUBRICATION FITTINGS

All three universal joints are equipped with pressure fittings—are easily lubricated during each lubrication period, and eliminate the need for periodic repacking. (Included in R.P.O. 330\*)

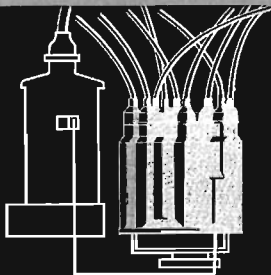

### HEAVY-DUTY IGNITION (6-cylinder engine)

Hotter spark plugs (AC 46) resist fouling in heavy traffic driving. A special distributor ground wire improves engine idle. (Included in R.P.O. 330\*)

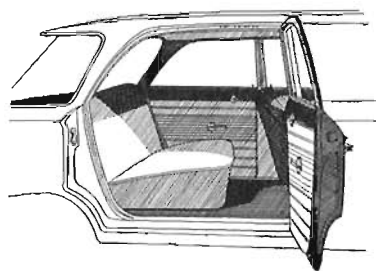

### WIDE-OPEN DOORS

1961 Chevrolet taxicab doors open wider—doorways are wider, too, for easier entry and exit. Husky door checks hold doors open wide while passengers enter and leave.

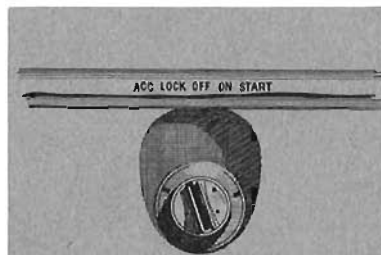

### 5-POSITION IGNITION SWITCH

Accessory position allows operation of electrical equipment with the ignition switch off. Key can be removed to open trunk without shutting off engine.

\*Extra-cost option.

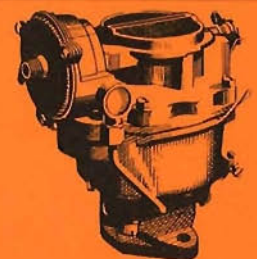

### SPECIAL TAXICAB CARBURETOR (6-cylinder engine)

Designed expressly for taxicab operation, this carburetor offers special fuel metering for exceptional gasoline economy in idle and stop-and-go driving. (Included in R.P.O. 330\*)



TAXICAB-BUILT

# BODY

BY FISHER

The inside story of Chevrolet-built taxicabs tells the ruggedness that's built into every detail of the roomy Body by Fisher. Heavy roof pillars, door sills, cowl, and crossmembers are integrated into one extra-strong structure mounted on ride-tuned body mounts for the very best in solid, silent comfort. Safety-type door latches hold the doors securely and prevent latch disengagement in any direction. Chevrolet's famous single-key locking system and keyless door locking offer unmatched convenience and security for the everyday hustle of in-and-out cab operation. Crank-operated ventipanes operate easily and stay where you want them. All these features, plus Safety Plate Glass in every window, parallel-action electric windshield wipers, and the luster and durability of Magic-Mirror acrylic lacquer finish add up to the greatest value for your taxicab dollar.

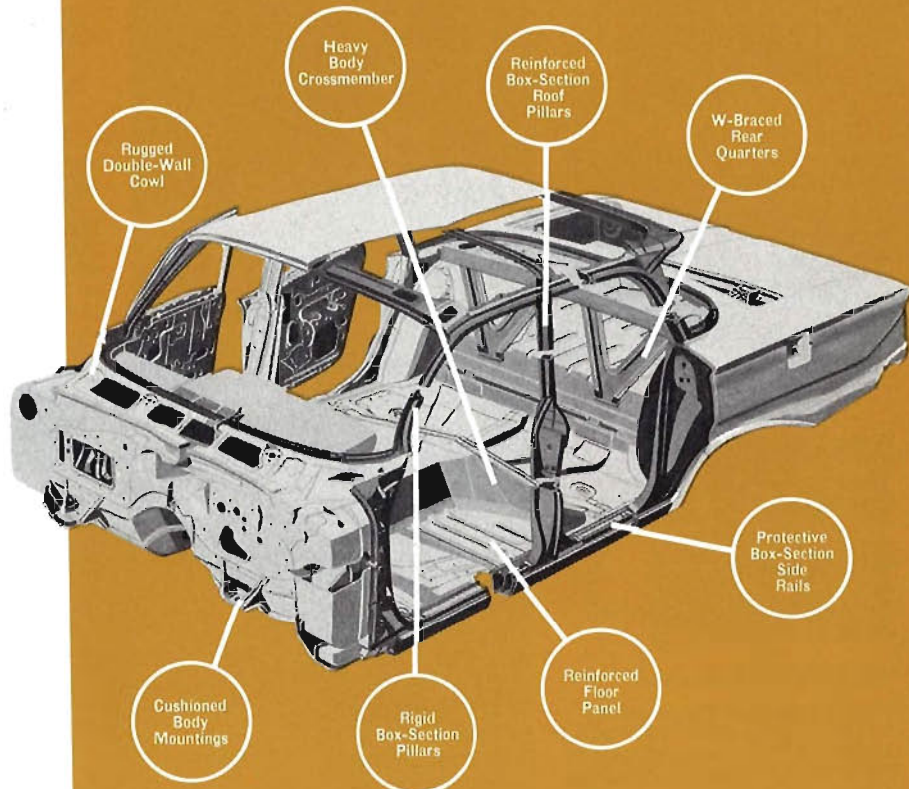

# CHOICE

OF INTERIORS

**Biscayne**—Standard Chevrolet Biscayne taxicab seats are upholstered in long-wearing color-keyed pattern cloth. Leather-grain vinyl around the seat edges, seat backs and door panels wipes clean quickly and easily. Special two-tone gray all-vinyl taxicab upholstery, vinyl headlining and sidewalls, and heavy-duty water-resistant floor mats are available at slight extra cost with R.P.O. 330.

**Biscayne Fleetmaster**—Standard seats are all-vinyl upholstered in attractive two-tone gray in addition to vinyl-coated sidewall trim panels in the Fleetmaster taxicab model. Vinyl headlining and heavy-duty, water-resistant floor mats are available as part of R.P.O. 330.

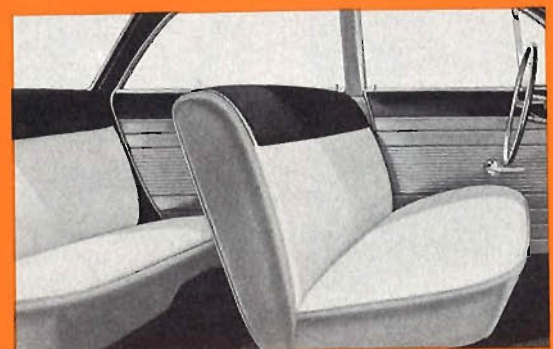

# NEW

## COMFORT ROOMINESS CONVENIENCE

The all-new 1961 Chevrolet body features functional new style with easier entry and exit—new roomy comfort for driver and passengers alike. Doorways are bigger, doors open wider, entrance height is greater, and there's more foot room in the rear. Comfort-high seats are deeply cushioned, and there's an abundance of head room, hip room and shoulder room for full three-passenger comfort both front and rear. Sidewalls are softly contoured, floors are heavily covered, and the entire body is acoustically hushed for a quiet, comfortable ride.

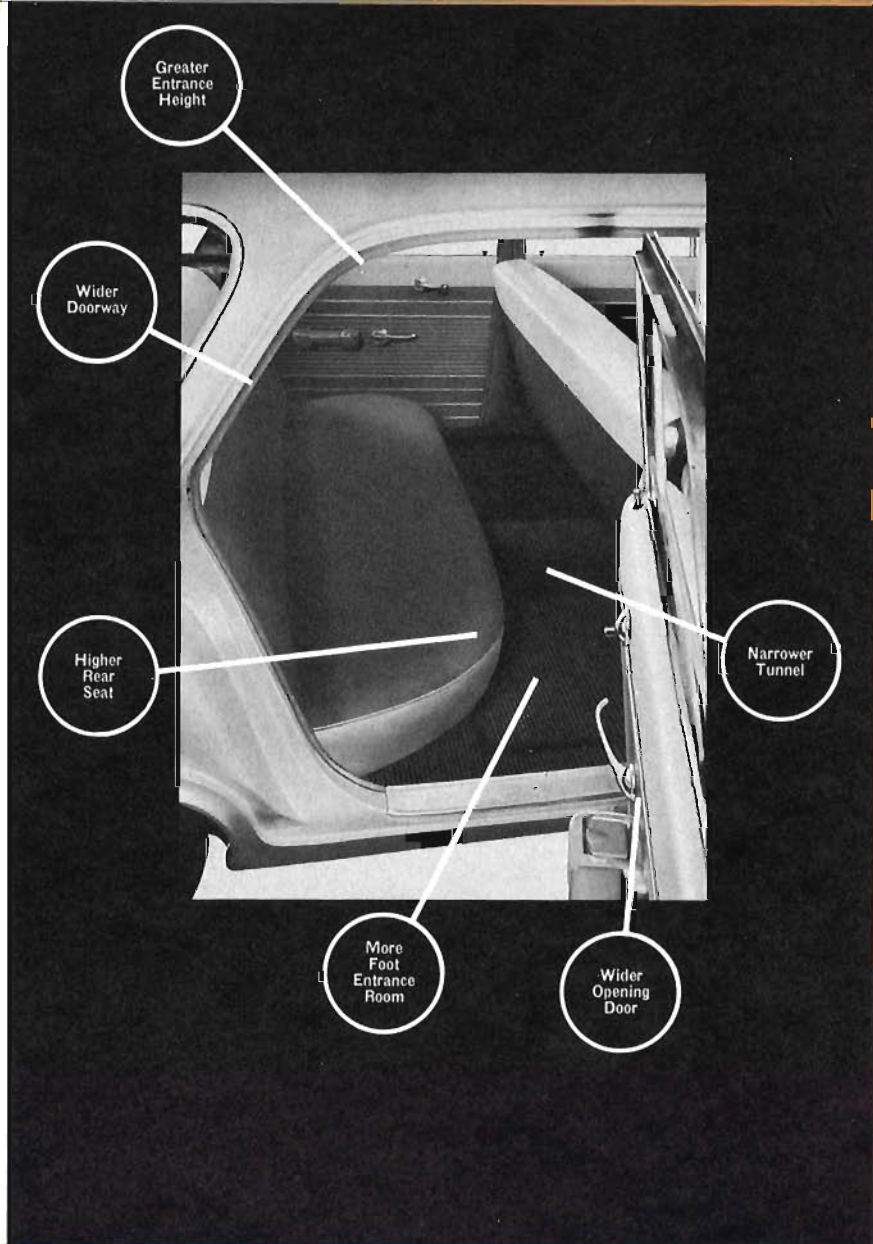

## NEW LUGGAGE COMPARTMENT

Here's functional design that's a natural for taxicab operators. The trunk floor is inches lower, and there's a lot more vertical space inside. The spare tire is out of the way, where it doesn't interfere with loading or unloading, yet convenient when needed. The fuel filler is now located in the left rear quarter panel. The trunk sill is as much as 10.5 inches lower—now at bumper level for the easiest loading and unloading. A wide trunk lid that opens higher makes contents accessible from the sides as well as from the rear. The deep lid is also ideal for large advertising signs. These signs raise with the lid—out of the way when you load.

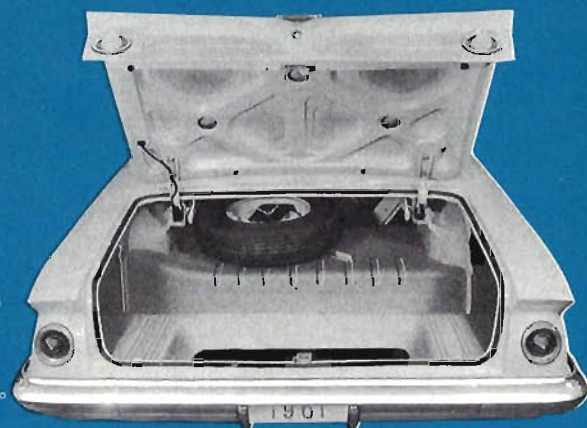



PRACTICAL POWER  
PLUS MONEY-SAVING

**ECONOMY**

HI-THRIFT

6

TAXICAB  
ENGINE

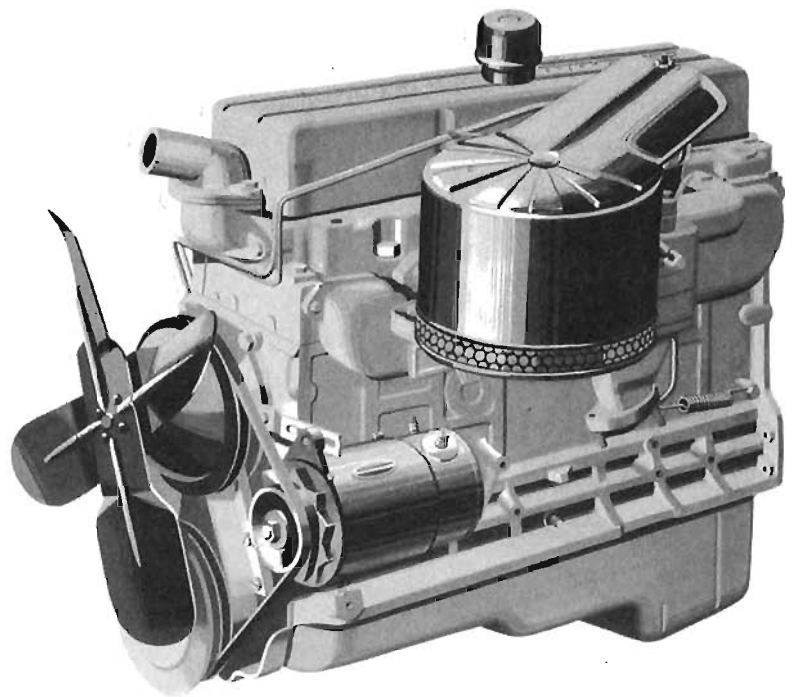

Chevrolet's reputation for gas-saving economy and long life has been proved by billions of miles of low-cost operation—more by far than any other engine offered in any other taxicab. The High-Thrift 6 valve system and carburetor are designed for economy and power in the lower speed ranges where most taxicabs operate. Wedge-shape combustion chambers and 8.25:1 compression ratio squeeze extra miles out of low-cost regular gasoline. Chevrolet's long list of quality engine features also includes an automatic choke and positive-shift starter for surer, quicker starts. Hydraulic valve lifters are featured in Biscayne models—mechanical valve lifters in the Biscayne Fleetmaster. An extra-economical taxicab carburetor is available as part of R.P.O. 330\*.

ECONOMY

**TURBO-FIRE**

V8

TAXICAB ENGINE

Here's extra power with remarkably low maintenance cost for long-haul taxicab operation. Low-friction short-stroke design with economy-contoured camshaft, gas-saving carburetor with automatic choke, and positive-shift starter stretch many miles from every gallon of regular fuel. All these features plus hydraulic valve lifters mean fuel-saving overall economy with exceptionally smooth, quiet operation.

\*Optional at extra cost.

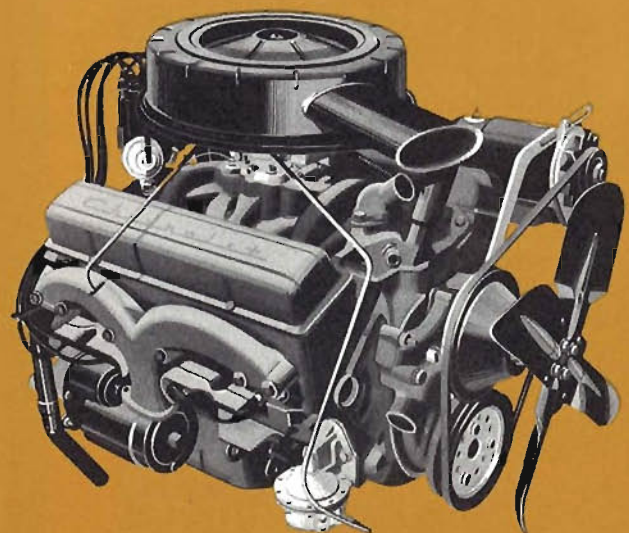

TAILORED  
**TRANSMISSIONS...**  
TAXICAB PROVED  
AND VELVET SMOOTH

3

SPEED SYNCHRO-MESH

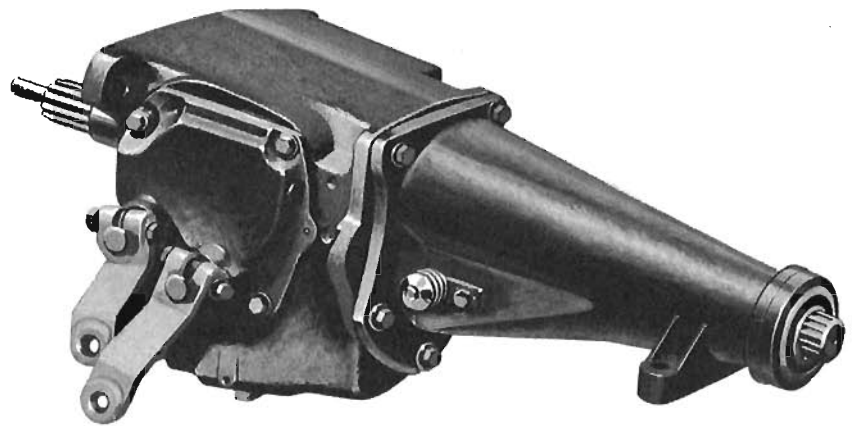

Chevrolet's all-helical gear 3-Speed Synchro-Mesh transmission has proved its smooth, quiet operation in stop-and-go taxi duty. Large synchronizers mean easier shifts without clashing and promote longer life. Linkage is cushioned from the transmission and driveline so that annoying, tiresome vibrations never reach the driver or passengers. Gear ratios have been engineered for a combination of performance and economy well suited to taxicab duty—for both the Hi-Thrift 6 and Economy Turbo-Fire V8 engines. Extra heavy-duty clutch and transmission components are included in R.P.O. 330\*.

**POWERGLIDE\***

(R.P.O. 313)

Powerglide is available in all Chevrolet taxicabs for added driving ease and smoothness. Driver and passengers ride more relaxed and every trip seems shorter. Powerglide's low first cost and billion-mile proved durability, plus driveline-saving smoothness, add up to a very low per-mile cost. An accelerator-controlled downshift furnishes extra power whenever the need arises. A lighted quadrant and positive parking lock add to safety and convenience. Automatic shifts occur at lower speeds in the taxicab Powerglide, increasing internal clutch durability.

\*Optional at extra cost.

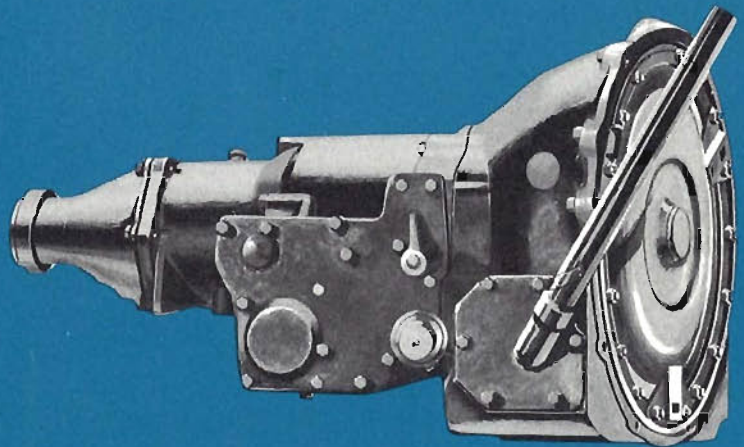



# RUGGED

## CHEVROLET TAXICAB

# CHASSIS

Ruggedness right down to the road is featured in the 1961 Chevrolet taxicab. Improvements throughout contribute to better braking, greater durability, and more passenger comfort. Long 119-inch wheelbase and wide wheel tread plus traditional Chevrolet attention to detail means a smoother, quieter ride—more comfort and safety in every mile.

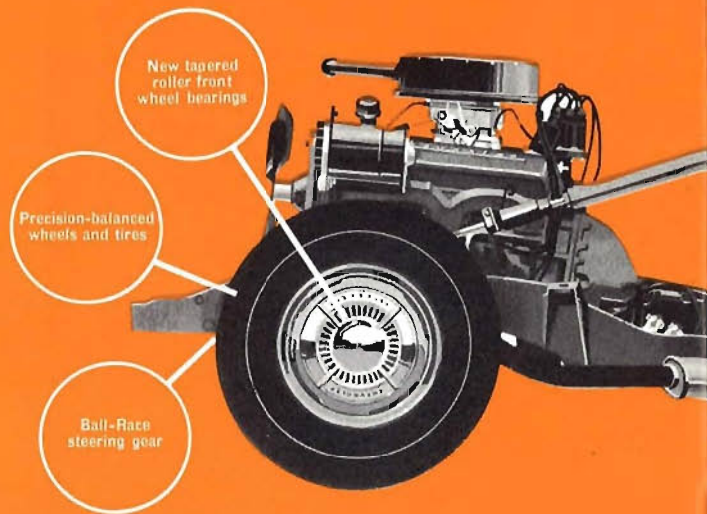

**Safety-Girder Frame** is X-built for superior torsional rigidity that keeps the entire car in better alignment. Doors and windows continue to open and close easily—hood and trunk lid fit right, too.

**Full Coil suspension** smooths and levels the ride along any road like no other in its field—keeps the car more level even during hard starts and stops.

# OPTIONS

## AND CUSTOM FEATURE ACCESSORIES\*

### COMFORT—SAFETY—APPEARANCE

HEATER-DEFROSTER De Luxe—outside air.....	F.O.A. 101
HEATER-DEFROSTER Recirculating.....	F.O.A. 116
2-SPEED ELECTRIC WINDSHIELD WIPER	
Includes pushbutton windshield washer.....	R.P.O. 333
DE LUXE STEERING WHEEL.....	R.P.O. 348
EXTRA-THICK FOAM FRONT SEAT CUSHION.....	R.P.O. 335
POWERGLIDE.....	R.P.O. 313

### POWER ASSISTS

POWER STEERING.....	R.P.O. 324
POWER BRAKES.....	R.P.O. 412

### HEAVY-DUTY AND MECHANICAL

HEAVY-DUTY CLUTCH	
For Hi-Thrift 6 engine (Included in R.P.O. 330).....	R.P.O. 227
OIL FILTER For Hi-Thrift 6 engine.....	R.P.O. 237
OIL-BATH AIR CLEANER For Hi-Thrift 6.....	R.P.O. 216
SPECIAL CRANKCASE VENTILATION SYSTEM.....	R.P.O. 242
HEAVY-DUTY BATTERY	
70-Ampere hour rating.....	R.P.O. 345

### SPECIAL ORDER EQUIPMENT

Equipment to meet the demands of unusual requirements and special types of operation should be discussed with your local authorized Chevrolet Dealer. He can advise what can be obtained on special order as factory-installed equipment.

### CUSTOM FEATURE ACCESSORIES

In addition to factory-installed equipment, Chevrolet offers a complete line of dealer-installed Custom Feature accessories. Included are many items particularly suited for taxicab use. Contact your local authorized Chevrolet Dealer for complete information.

### SPECIAL GENERATORS\*\*

- (A) GENERATOR, 30-AMPERE (Standard)—Included here as basis of comparison.
- (B) GENERATOR, 35-AMPERE (R.P.O. 338)—Extra output standard-duty generator. For use in taxicabs without two-way radio.
- (C) GENERATOR, 40-AMPERE (R.P.O. 326)—High-output medium-duty generator. For use in taxicabs without two-way radio.
- (D) GENERATOR, 35-AMPERE LOW CUT-IN (L.P.O. 1000)—Medium-duty generator for peak output at lower speeds. For use in city operation.
- (E) GENERATOR, 50-AMPERE LOW CUT-IN (R.P.O. 378)—Generator with extra-heavy-duty construction, for higher current at very low speeds, such as city taxi operation with two-way radio.
- (F) GENERATOR, 60-AMPERE ALTERNATOR TYPE (Special Order Option)—Heavy-duty self-rectifying alternating current generator fits standard generator mounting. All-transistor regulator. Produces high output at idle and low speeds. Special for taxicabs with two-way radio.

\*Options and Custom Feature Accessories at extra cost.

\*\*Contact your local authorized Chevrolet Dealer for other special generators and alternators to fill special requirements.

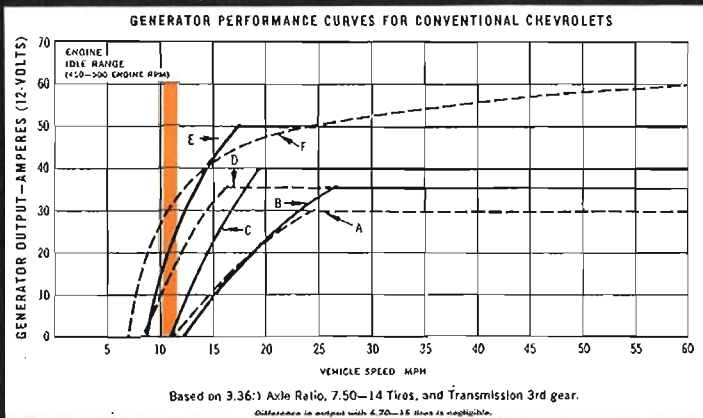



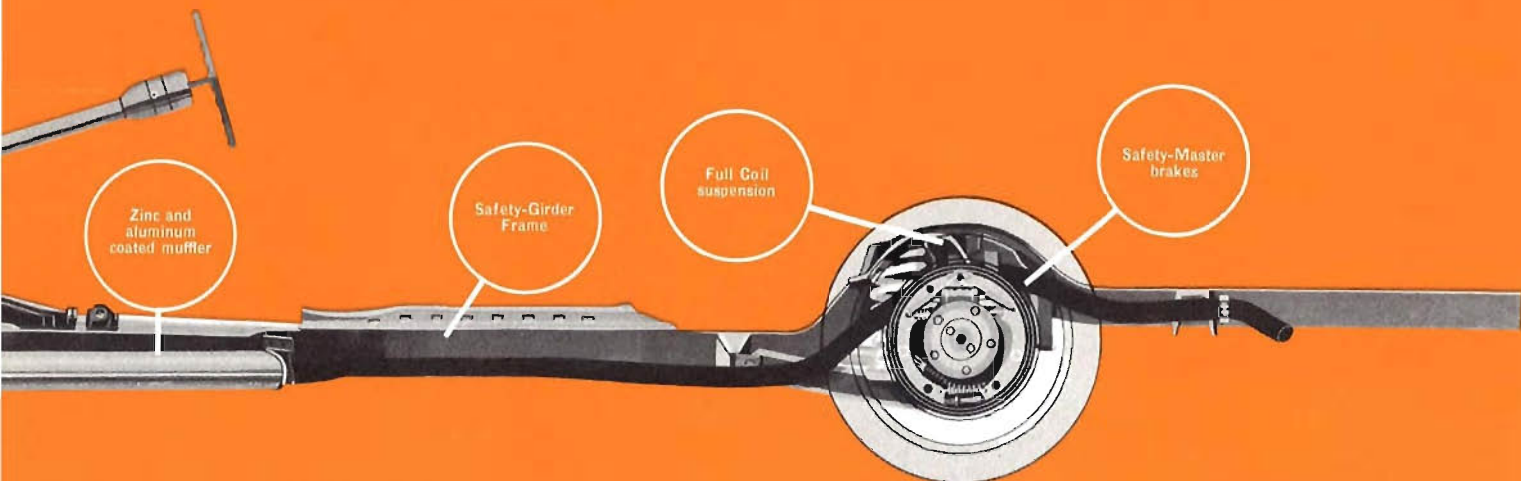

**Safety-Master brakes** feature bonded linings that last up to twice as long as conventional riveted types. Brakes stay cooler with extra-large flared drums and built-in cooling slots in each wheel.

**Ball-Race steering gear** makes maneuvering in and out of tight traffic situations easier. Jointed, cushioned steering shaft isolates annoying road shock from the steering wheel.

**New tapered roller front wheel bearings** add many miles of trouble-free operation in hard taxicab service.

**Precision-balanced wheels and tires** extend tire life and promote a smooth ride. Slotted wheels permit easy installation of emergency strap-on tire chains for the roughest driving weather.

**Zinc and aluminum coated muffler** contributes to exhaust system durability and long life.

# R.P.O. 330

## SPECIAL TAXICAB OPTION PACKAGE

Equipment especially desired for taxi duty is offered in a single "package" which includes factory-installed chassis and body features—available at nominal cost and fully described on pages 4 and 5.

- 15" wheels and Tyrex cord tires
- Choice of interior trim
- Heavy-duty rear axle and wheel bearings
- Metallic-lined spherical joints
- Open-door warning light
- Heavy-duty ignition (6-cyl. only)
- Automatic light switches
- Driveshaft lubrication fittings
- Heavy-duty water pump and fan pulley (6-cyl. only)
- Heavy-duty springs
- Heavy-duty front and rear floor mats
- Heavy-duty brake drums and hubs
- Rear door armrests
- Special taxicab carburetor (6-cyl. only)
- Heavy-duty front seat
- Heavy-duty rear seat
- Heavy-duty transmission (6-cyl. only)
- Heavy-duty clutch (6-cyl. only)
- Heavy-duty shock absorbers
- Reinforced taxicab frame
- Heavy-duty rear suspension bushings



# CORVAIR

# TAXICAB

BY CHEVROLET

For taxicab operation at its lowest practical cost, here's unmatched value. Corvair's extra-low first cost, excellent gasoline mileage, and overall operating economy make taxicab dollars go farther. There's full 6-passenger roominess with wide seating and virtually flat floors. Corvair's many extra benefits include brisk maneuverability and trim overall size that lets it squeeze into tight places quickly and easily. There's more fun in a day's work with Corvair's spirited performance and ease of driving. At every turn, there's less stress and strain on the driver because Corvair steers so easy, it's almost like power steering—without the added expense and upkeep. Whether operating with a full payload or just the driver alone, Corvair rides smoothly—cornering is positive, precise. Corvair's rough-weather traction helps keep you and your fares on schedule—and there's less chance of getting stuck, no matter how bad the roads become.

Corvair 500 4-Door 6-Passenger Taxicab

THE INCOMPARABLE

# GREENBRIER

TAXICAB

Here's a new kind of taxicab that's just right for many unusual tasks. The Greenbrier, with its roominess and unique features can handle jobs other cabs can't. In the front and rear seats, including the optional third seat\* for up to a full 9-passenger capacity, seating width is approximately five feet.

All seats are comfort-high, with head and leg room more than ample. Even with a full payload there's plenty of luggage space. For zone-fare and small inter-city bus operation, the Greenbrier is powerful, quick, and highly maneuverable. Drivers appreciate the excellent visibility and easy steering. Parking's easier, too, because the length of the Greenbrier is actually more than two feet less than most taxicabs now in operation. Taxicab owners appreciate the high gasoline and tire mileage and low operating cost.

Corvair Greenbrier Sports Wagon Taxicab





# RUGGED, ECONOMICAL CORVAIR TAXICAB

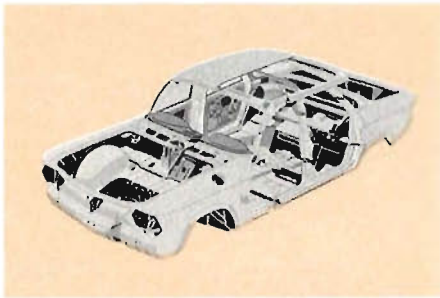

## Body (Corvaire 500 4-Door Taxicab)

Corvaire's Monostrut Body by Fisher features single-unit construction, combining body and frame into one rigid steel structure. The body is sealed and insulated for snug, quiet comfort. Safety Plate Glass in all windows, plus the security of safety-type door latches, offers seeing and driving safety for driver and passengers alike.

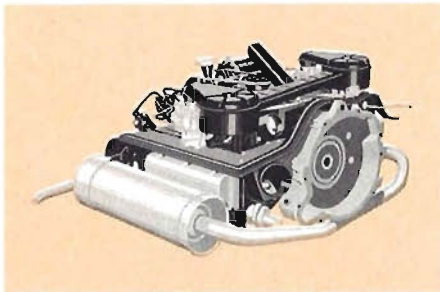

## Turbo-Air 6 (All models)

The Turbo-Air air-cooled aluminum engine with low-friction, short-stroke design means long engine life and excellent gasoline economy. A positive-shift starter prevents gas-wasting false starts, and hydraulic valve lifters never need periodic adjustment. Forced-air cooling system eliminates the need for water, expensive antifreeze, and costly seasonal maintenance. Overheating in heavy traffic is a thing of the past with a Corvaire taxicab!

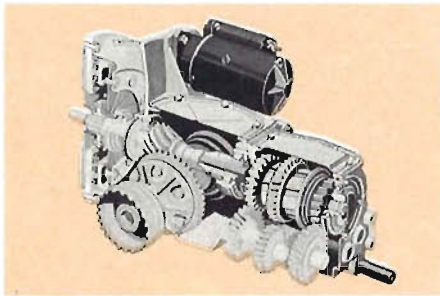

## Transaxle (All models)

Here's one of the big reasons for Corvaire's virtually flat floor. Transmission and differential gears are combined in a compact low-weight unit mounted between the rear wheels. Combined with the rear-mounted Turbo-Air engine, Corvaire's transaxle unit eliminates the need for a driveshaft extending under the floor—there's less vibration and driveline sounds are behind, not in front of, driver and passengers. Available with 3- or 4-Speed Synchro-Mesh or Corvaire Powerglide automatic transmission.

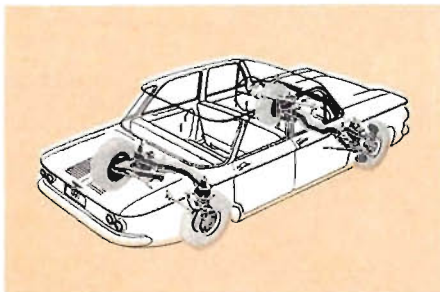

## Quadri-Flex Full-Independent Suspension (All models)

Corvaire's exclusive 4-wheel independent suspension system offers new highs in comfort, roadability, and durability. Each wheel cushions bumps separately—there's no cross-transfer of road shocks from wheel to wheel. Corvaire's deep coils smooth and level the ride with sure-footed softness. Also . . . coil springs can't wear out, can't squeak, and never need lubrication or replacement of inter-leaf liners as with ordinary leaf springs.



## CORVAIR TAXICAB

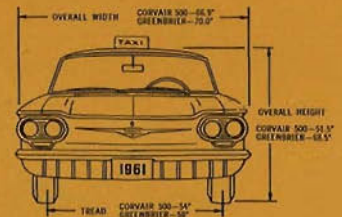
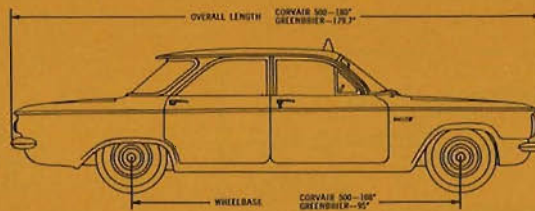

# SPECIFICATIONS

**BODY—CORVAIR 500 AND CORVAIR GREENBRIER:** Single unit body-frame structure, sealed and insulated. Extra-heavy pillars and roof rails, reinforced floor, double-walled front structure, and High-Level ventilation. Single-key locking system, pushbutton outside door handles. Dual electric parallel-action windshield wipers, directional signals, center dome light with instrument panel switch, left-hand sun visor, front ashtray, recessed-hub steering wheel with central hornbutton. CORVAIR 500: Monostrut Body by Fisher features double-walled cowl, Safety Plate Glass in all windows. 16" two-spoke steering wheel. Foam cushioned front seat. Pattern cloth seat upholstery, vinyl-coated side-wall inserts, cloth headlining. Lined inside stowage compartment. Black rubber floor mats. GREENBRIER: Special van-type body features double side and rear doors, synthetic enamel finish, Safety Plate Glass in windshield (safety sheet glass in all other windows). Pattern cloth seat upholstery, painted sidewall inserts, and vinyl headlining between roof bows. Foam cushioning in all seats. Black rubber floor mats.

**ENGINE—80-h.p. TURBO-AIR.** Horizontally opposed 6-cylinder valve-in-head aluminum design. 145-cu.-in. displacement, 3.4375" x 2.60" bore and stroke, 8.0:1 compression ratio, twin carburetors, single exhaust. Forced-air cooling by centrifugal blower, thermostatically controlled air flow, finned cast ferrous alloy cylinders. Aluminum pistons. Forged steel crankshaft. Finned aluminum cylinder heads with integral intake manifolds and alloy steel valve seat inserts. Full pressure lubrication system, full-flow oil filter, oil cooler, four-quart refill. Hydraulic valve lifters, manual choke, positive-shift starter, dual oil-wetted air cleaners.

**TRANSAXLE UNIT—**Combines transmission and final drive gears in compact unit with differential between engine and transmission. Power is transferred from engine to transmission by an input shaft that passes through the hollow differential hypoid pinion and transmission output shaft. **3-SPEED SYNCHRO-MESH:** All helical gear design with floor-mounted shift lever. **CORVAIR POWERGLIDE\*:** Two-speed three-element torque converter with hydraulically controlled planetary gears. Range selector on instrument panel. Selector sequence L-D-N-R. **REAR AXLE:** Hypoid type. Ratios: 3.27:1 in Corvair 4-Door Sedan; 3.89:1 in Greenbrier. Other ratios optional\*.

**CLUTCH—**Diaphragm spring type, molded lining, permanently lubricated release bearing.

**CHASSIS—SUSPENSION:** Quadri-Flex independent suspension with coil springs at all four wheels. Spherical joint front suspension with built-in levelizing control. Rubber-pivoted control arms with swing axle in rear. Permanently lubricated rear wheel bearings. Direct, double-acting shock absorbers. **WHEELS AND TIRES:** Corvair Sedans: 6.50 x 13 tires. Greenbrier: 7.00 x 14 tires. 4-ply rating blackwall tubeless tires on all models. Spare tire and wheel. **BRAKES:** Safety-Master hydraulic design; 9" diameter drums on Corvair 4-Door Sedan, 11" on Greenbrier; bonded linings—120.8 sq. in. effective area on Corvair 4-Door Sedan, 166.8 sq. in. on Greenbrier. Hand-operated mechanical parking brake, trigger release. **STEERING:** Precision Ball-Race gear; overall ratio 23.5:1 on Corvair 4-Door Sedan, 23:1 on Greenbrier. **FUEL CAPACITY:** 14-gallon tank on Corvair 4-Door Sedan, 18.5-gallon tank on Greenbrier. **ELECTRICAL:** 12-volt system, 30-ampere generator, 42-plate battery.

**DIMENSIONS—CORVAIR 4-DOOR SEDAN:** Wheelbase 108", front and rear tread 54", length 180.0", width 66.9", height (loaded) 51.5". **GREENBRIER:** Wheelbase 95", front and rear tread 58", length 179.7", width 70.0", height (loaded) 68.5".

### OPTIONAL EQUIPMENT\*

These Corvair special Taxicab packages include all the factory-installed features that offer extra durability and convenience.

#### R.P.O. 330—CORVAIR 500 SEDAN

- Choice of Interiors—Standard Interior—Gray pattern cloth seats with vinyl-coated side-wall trim, and cloth headlining. Optional All-Vinyl Interior—Optional at slight extra cost with R.P.O. 330, includes heavy-duty vinyl seat upholstery and vinyl headlining that wipes clean easily.
- Heavy-Duty Front Floor Mat—Thick black rubber mat is backed with heavy asphalt-impregnated insulation to prevent water-soaking. Extra reinforcement at base of accelerator pedal contributes to durability.
- Heavy-Duty Rear Floor Mat—Formed heavy black rubber mat and asphalt-impregnated pad wear longer and resist water-soaking.
- Heavy-Duty Front and Rear Seats—Reinforced S-wire seat cushions and backrests maintain seat contours to keep seats looking better longer.
- Rear Door Armrests—Door-pull armrests on rear doors make door closing easier, help passengers in and out.
- Heavy-Duty Rear Springs—Two super-tough coil springs help add extra stability and durability in street-pounding taxicab operation.
- Heavy-Duty Front Shock Absorbers—Special valving for firmer control increases stability in turns and over rough streets.
- Universal Joint Lubrication Fittings—Special fitting at each axle shaft universal joint allows quick lubrication—eliminates the need for repacking at regular intervals.

#### R.P.O. 420—GREENBRIER

- All-Vinyl Seat Upholstery—Extra-heavy two-tone gray vinyl is used on seat cushions for extra-long life and easy cleaning.
- Heavy-Duty Front Floor Mat—Mat is backed with asphalt-impregnated insulation to prevent water-soaking.

- Heavy-Duty Rear Floor Mat—Rear passenger compartment floor mat is extra durable vinyl-coated rubber.
- Spare Tire Cover—An appearance item that also keeps luggage from rubbing against spare tire.
- Door Striker Cover—Prevents snagging or soiling of clothing on side doors.
- Side Door Warning Light—Light on instrument panel warns driver if the forward door of the double side doors is open.
- Special Second Seat Mounting—Second seat is mounted forward to a position immediately behind the front seat—allows greater access to cargo compartment.
- Heavy-Duty Front Shock Absorbers—Special valving for firmer control increases stability in turns and over rough streets.
- Universal Joint Lubrication Fittings—Special fittings at each axle shaft universal joint allows quick lubrication—eliminates the need for repacking at regular intervals.
- Heavy-Duty Battery—54-Plate, 40-Ampere rating.

### FACTORY-INSTALLED OPTIONAL EQUIPMENT\*

#### POWER TEAMS

- |                       |                                     |
|-----------------------|-------------------------------------|
| 4-Speed Synchro-Mesh  | For Corvair 4-Door Sedan R.P.O. 651 |
|                       | For Greenbrier R.P.O. 652           |
| Corvair Powerglide    | For Corvair 4-Door Sedan R.P.O. 360 |
|                       | For Greenbrier R.P.O. 667           |
| Axle Ratio—3.55:1     | For Corvair 4-Door Sedan R.P.O. 693 |
| With all power teams. |                                     |
| Axle Ratio—3.89:1     | For Corvair 4-Door Sedan R.P.O. 662 |
| With all power teams. |                                     |

#### COMFORT—SAFETY—CONVENIENCE

- |  |                          |            |
|--|--------------------------|------------|
| Heater-Defroster   | For Greenbrier           | F.O.A. 129 |
| Aircraft-type (Available as Dealer-Installed Custom Feature for Corvair 4-Door Sedan)  |                          |            |
| Heater-Defroster   | For Corvair 4-Door Sedan | F.O.A. 113 |
| Forced-Air type  | For Greenbrier           | F.O.A. 138 |
| 2-Speed Electric Windshield Wiper  | For Corvair 4-Door Sedan | R.P.O. 333 |
| Includes Pushbutton Windshield Washer.   | For Greenbrier           | R.P.O. 355 |
| De Luxe Body Equipment   | For Corvair 4-Door Sedan | R.P.O. 347 |
| Includes cigarette lighter, right-hand sun visor, front armrests.  |                          |            |
| Comfort and Convenience Equipment  | For Corvair 4-Door Sedan | F.O.A. 120 |
| Includes backup lights, outside rearview mirror, 2-speed electric windshield wiper and windshield washer, glove compartment light. |                          |            |
| Rear Door Armrests   | For Corvair 4-Door Sedan | R.P.O. 248 |
| Included in R.P.O. 330, available as Dealer-Installed Custom Feature for Greenbrier.   |                          |            |
| Spare Tire Lock  | For Corvair 4-Door Sedan | R.P.O. 384 |
| Rear (Third) Seat  | For Greenbrier           | R.P.O. 269 |
| Double Left-Hand Side Doors  | For Greenbrier           | R.P.O. 645 |

#### HEAVY-DUTY EQUIPMENT

- |                                  |                                     |
|----------------------------------|-------------------------------------|
| Heavy-Duty Battery               | For Corvair 4-Door Sedan R.P.O. 345 |
| 54-Plate, 40-Ampere hour rating. | and Greenbrier                      |
| Included in R.P.O. 420.          |                                     |

#### CUSTOM FEATURE ACCESSORIES\* AND SPECIAL ORDER EQUIPMENT

In addition to factory-installed optional equipment, Chevrolet offers a complete line of dealer-installed Custom Feature accessories—many particularly suited for taxicab use. Special order equipment to meet the demands of specialized operation is also available. Contact your local authorized Chevrolet Dealer for complete information.

#### GENERATORS

- (A) Generator, 30-Ampere (Standard)  
 (B) Generator, 35-Ampere (R.P.O. 650\*) Low cut-in medium-duty generator for peak output at lower speeds.

#### NEW TWO-WAY RADIO EQUIPMENT FOR CORVAIR TAXICABS

Three new transistor-type two-way radios are commercially available for Corvair: A 10-Watt unit can be used with the standard Corvair generator and battery; a 30-Watt unit is suitable for use with standard generator and heavy-duty battery (54-plate, 40-ampere hour rating); and a 75-Watt unit with which the heavy-duty 35-ampere low-cut-in generator and heavy-duty battery must be used. Consult your local radio supplier for latest information about this equipment.

\*Optional at extra cost.



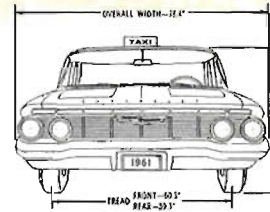
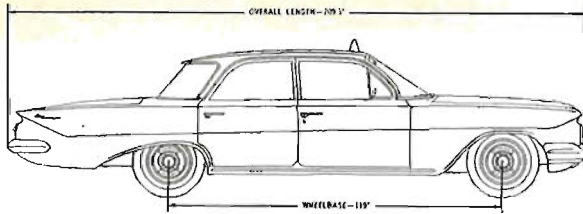

## BISCAYNE AND BISCAYNE FLEETMASTER 4-DOOR TAXICABS

# SPECIFICATIONS

## MODELS 1169 and 1369 (6-cyl.)—and 1269 and 1469 (V8)

### POWER TEAMS FOR TAXICABS

	Synchro-Mesh	Powerglide
Hi-Thrift 6.....	•	•
Economy Turbo-Fire V8.....	•	•

### ENGINE

**Hi-Thrift 6**—135 horsepower at 4000 r.p.m., 235.5-cu.-in. 6-cylinder, 3.56" bore and 3.94" stroke, 8.25:1 compression ratio. Single-barrel carburetor with oil-wetted air cleaner (oil-bath type optional\*). Taxi-engineered economy carburetor included in R.P.O. 330\*. Hydraulic valve lifters in Biscayne—mechanical valve lifters in Biscayne Fleetmaster. Shaft-mounted rocker arms, replaceable valve guides, four main bearings, gear-driven camshaft, by-pass type oil filter\*, five-quart oil refill (without filter).

**Economy Turbo-Fire V8**—170 horsepower at 4200 r.p.m., 283-cu.-in. V8, 3.88" bore and 3.0" stroke, 8.5:1 compression ratio. Two-barrel carburetor with replaceable element air cleaner. Hydraulic valve lifters. Single exhaust system. Features independent operating mechanism for each valve, integral valve guides, chain-driven camshaft, five main bearings, full-flow oil filter, four-quart oil refill (without filter).

**Both engines**—Valve-in-head design, aluminum pistons, forged steel crankshaft, replaceable insert main and connecting rod bearings, full-pressure lubrication, 12-volt electrical system, positive-shift starter, automatic choke. Cooling system has tube-on-center radiator, 13-pound pressure cap.

### TRANSMISSION

**Synchro-Mesh**—Three-speed all helical gear, high torque capacity Synchro-Mesh, hardened shot-peened gears, cam and roller shift mechanism. Gear ratios: first 2.94:1, second 1.68:1, third 1:1, reverse 3.33:1.

**Powerglide**\*—Three-element torque converter (pump, turbine, and stator) with automatically controlled planetary gears in "Drive" range, manually selected for "Low" and "Reverse." Positive parking lock. P-R-N-D-L selector quadrant on steering column. Engine starts in either "Park" or "Neutral."

### CLUTCH

9 1/2" diaphragm spring type clutch standard with Hi-Thrift 6 engine—10" standard with Economy Turbo-Fire V8. 11" heavy-duty semi-centrifugal diaphragm-spring type clutch optional\* for Hi-Thrift 6 (included in R.P.O. 330\*). Clutches have cushioned disc and permanently lubricated release bearing.

### CHASSIS

**Frame and Suspension**—Tunnel-center X-built Safety-Girder frame. Full Coil suspension, double-acting shock absorbers and built-in leveling control (heavy-duty coil springs and shock absorbers included in R.P.O. 330\*). Independent front suspension with self-adjusting spherical joint steering knuckles. Four-link rear suspension with rugged control arms controls axle movement. Front ride stabilizer bar on V8 models.

**Wheels and Tires**—14" wheels, 7.50 x 14 4-ply rating low-pressure Tyrex cord tubeless tires standard (15" wheels and 6.70 x 15 4-ply rating tires included in R.P.O. 330\*).

**Brakes**—Hydraulic Safety-Master brakes with bonded linings. Total lining area 199.5 square inches. 11" diameter drums. Foot-operated mechanical parking brake, finger-tip release.

**Steering**—Ball-Race steering gear, balanced relay linkage. Overall ratio 28:1.

**Rear Axle and Propeller Shaft**—Hypoid, semi-floating rear axle with banjo-type housing. Axle ratio matched to power team. Two-section tubular propeller shaft and three pre-lubricated universal joints (lubrication fittings included in R.P.O. 330\*) with rubber-mounted center bearing.

**Fuel Tank**—Fuel tank with filter screen is vented to speed filling. 20-gallon tank capacity. Filter in left rear quarter panel.

**Electrical system**—12-volt electrical system, 54-plate battery (53-ampere hour rating at 20 hours). 30-ampere generator with sealed voltage and current regulator (heavy-duty generator or AC alternator optional\*).

### BODY

**Structure**—All-welded Fisher Unisteel construction. Double-walled cowl and unitized sides. Box-section pillars and floor side rails. Reinforced steel floor and top, W-strut bracing behind rear seat. Double-walled doors, triple-safe rotary latches. Single key operates all locks. Front-opening double-panel hood, automatic latch and safety catch. High-Level cowl ventilation inlet. Large rear luggage compartment, automatic locking lid with counter-balancing hinges and key release. Fully sealed and insulated body, cushioned mountings.

**Interior**—Seats with S-wire springs (heavy-duty springs included in R.P.O. 330\*). Combination pattern cloth and leather-grain vinyl seat upholstery in Biscayne (two-tone gray heavy-duty all-vinyl available with R.P.O. 330\*), all-vinyl standard in Biscayne Fleetmaster. (Manual inclined-plane front seat adjustment. Cloth headlining (except with optional all-vinyl interior). Front armrests in Biscayne (rear armrests included in R.P.O. 330\*). Two-spoke recessed-hub steering wheel and horn button. Top mounted rearview mirror. Ceiling light controlled by instrument panel switch (automatic light switches at all 4 doors included in R.P.O. 330\*) Rubber floor mats front and rear (all-rubber heavy-duty mats included in R.P.O. 330\*). Spare wheel and tire, bumper jack, and wheel wrench stowed in luggage compartment.

**Instrument Panel and Controls**—Central ashtray. Central glove compartment with key lock. Instruments: Speedometer and odometer, temperature and fuel gauges, generator and oil pressure lights, country-beam and directional signal indicator lights. Easily-removable instrument cluster. Light switch controls headlights, parking lights, instrument panel lights and dome light. Windshield wiper control and starter-ignition switch included in group. Optional\* heater-defroster controls at right of driver. Control knob for air vents under each end of instrument panel. Finger-tip release for foot-operated parking brake. Directional signal and shift levers on steering column.

**Windows**—Safety Plate Glass in all windows. One-piece curved windshield. Crank-operated front vent windows and side windows. Fullview rear window. Dual electric parallel-action windshield wipers.

### FACTORY-INSTALLED OPTIONS\*

See list of Chevrolet options for taxicabs on page 10 of this book.

### SEAT DIMENSIONS

	FRONT	REAR
Leg Room.....	45.0"	42.0"
Head Room (effective).....	39.5"	38.0"
Hip Room.....	63.5"	63.5"
Shoulder Room.....	59.0"	58.0"

All illustrations and specifications contained in this literature are based on the latest product information available at the time of publication approval. The right is reserved to make changes at any time without notice in prices, colors, materials, equipment, specifications and models, and also to discontinue models.

CHEVROLET MOTOR DIVISION OF GENERAL MOTORS CORPORATION  
DETROIT 2, MICHIGAN

\*Optional at extra cost.

FOR THE GREATEST VALUE IN TAXICABS—SEE YOUR LOCAL AUTHORIZED CHEVROLET DEALER