

# 1963 CUSTOM FEATURE ACCESSORIES FOR ALL CHEVROLET TRUCKS

INDEX	PAGE
CUSTOM HEATERS AND DEFROSTERS FOR LIGHT, MEDIUM AND HEAVY TRUCKS	2
CUSTOM HEATERS AND DEFROSTERS FOR CORVAIR 95 TRUCKS	3-4
CHEVROLET CUSTOM ACCESSORIES FOR CHEVROLET PICK-UPS	5-6
CHEVROLET CUSTOM FEATURE ACCESSORIES FOR ALL TRUCKS WITH DELUXE OR STANDARD CAB	7-8
CHEVROLET CUSTOM FEATURE ACCESSORIES FOR ALL CORVAIR 95 TRUCKS	9-10
CHEVROLET CUSTOM FEATURE ACCESSORIES FOR ALL MODEL TRUCKS	11-12
CHEVROLET CUSTOM FEATURE ACCESSORIES FOR MEDIUM DUTY TRUCKS	13-14
CHEVROLET TRUCK AIR CONDITIONERS	15
CHEVROLET CUSTOM FEATURE ACCESSORIES FOR PANEL TRUCKS	16
CHEVROLET CUSTOM FEATURE ACCESSORIES TO COMPLY WITH STATE AND FEDERAL LAWS	17-18
CHEVROLET CUSTOM FEATURE ACCESSORIES FOR HEAVY DUTY TRUCKS	19-20

All illustrations and specifications in this literature are based on the latest product information available at the time of publication approval. The right is reserved to make changes at any time without notice in colors, materials, equipment specifications and models, and also to discontinue items or models.

Typeset by ...  
revised ...  
General Motors Corporation,  
Service Technology Group.

© 1960  
Chevrolet Motor Division  
General Motors Corporation

Chevrolet Motor Division  
General Motors Corporation  
Detroit 2, Michigan

## CUSTOM HEATERS FOR CHEVROLET LIGHT-MEDIUM

### RECIRCULATING HOT WATER HEATER AND DEFROSTER

The large copper heater core is heated by hot water from the engine and the heated air circulation in the cab interior is controlled by a three speed centrifugal blower. The defroster and blower motor control knobs are an integral part of the instrument panel. The high capacity air distribution assures sufficient heat to the defrosters to keep the windshield clear of steam, ice and snow.

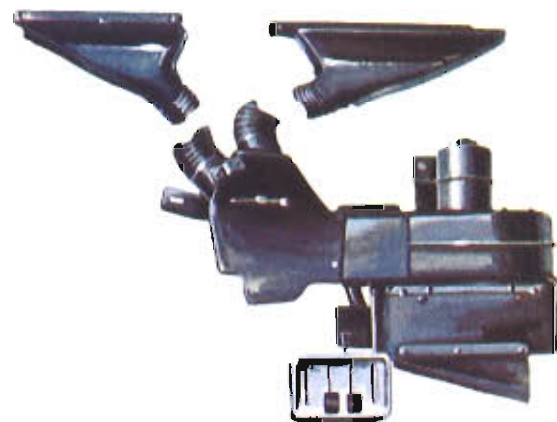

## AND DEFROSTERS AND HEAVY TRUCKS

### DELUXE HOT WATER HEATER AND DEFROSTER

A modern heating and ventilating system that can be used with outside air, re-circulated air or a mixture of both to reduce window steaming or fogging on damp rainy days and to remove smoke or stale air from the cab interior. The high volume air circulation through the air distribution ducts and defrosters assures rapid removal of snow and ice from the windshield.

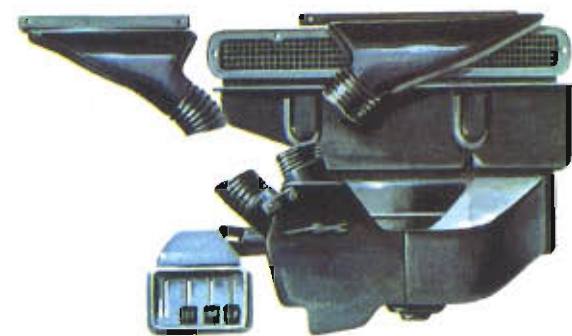

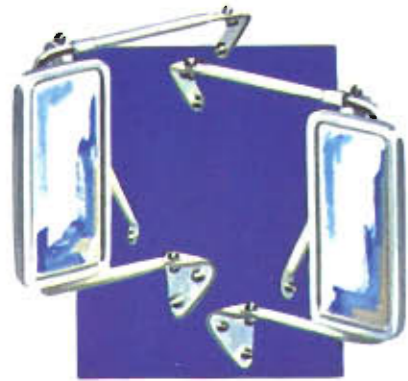

**RIGHT OR LEFT HAND  
REAR VIEW MIRRORS**

A 7 x 16 inch mirror with chrome coated glass that will not fog or discolor and is adjustable.



**WHEEL COVERS**

Set of four, 14 inch stainless steel covers with a chrome flash finish.



**FRONT BUMPER GUARDS**

Spring steel bumper guards either painted or chrome to match bumper face bar.

**CUSTOM  
HEATERS AND  
DEFROSTERS  
FOR CORVAIR  
95 TRUCKS**



A perimeter type heater that utilizes the engine heat rejection principle to provide fast heating and defrosting.

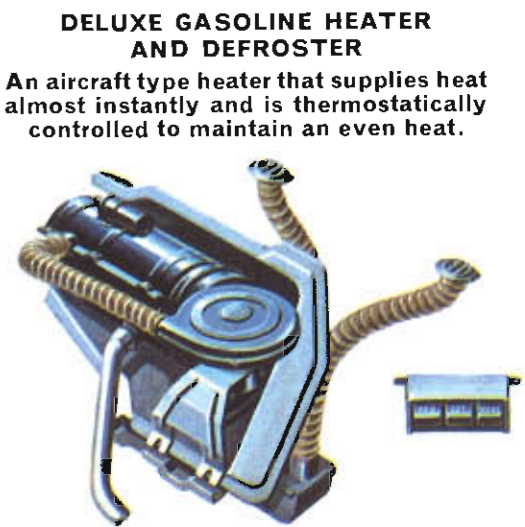

An aircraft type heater that supplies heat almost instantly and is thermostatically controlled to maintain an even heat.

**CUSTOM FEATURE ACCESSORIES FOR CORVAIR 95 TRUCKS**



**CUSTOM MANUAL RADIO  
AND ANTENNA**

A modern all transistor radio that starts to play instantly.



**RIGHT OR LEFT HAND  
SAFETYLIGHT**

A powerful lamp, adjustable from inside the vehicle incorporating a rear view mirror.

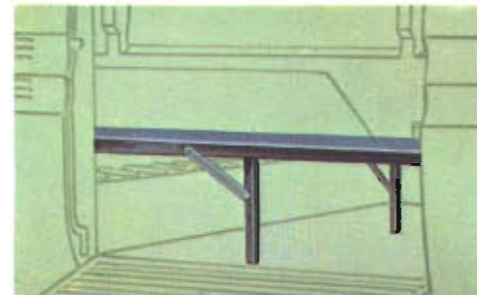

**LEVEL FLOOR AND ADAPTER**

All the necessary metal brackets and parts to install on model 1254 Rampside.



**ARM REST AND ADAPTER**

A sturdy vinyl covered arm rest and adapter that reduces driving fatigue, and as a door pull to close door.

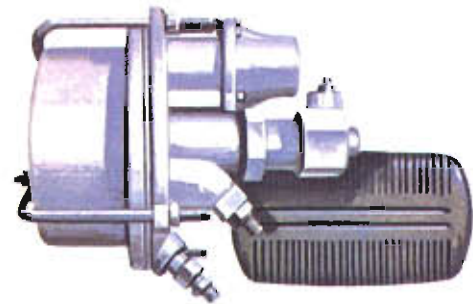

**POWER BRAKE**

A low pedal type power brake for all one half to one ton trucks.



**CHROME**

**PAINTED**

**FRONT BUMPER GUARDS**

Spring steel guards either painted or chrome to match bumper face bar.



**RADIO AND ANTENNA**

A modern all transistor radio that starts to play instantly.



**BACK-UP LAMPS**

Automatically provides light to the rear of the vehicle when shifted into reverse.

**CUSTOM FEATURE ACCESSORIES FOR CHEVROLET PICK-UPS**



**RIGHT OR LEFT HAND REAR VIEW MIRRORS**

A 7½ x 10½ inch mirror with chrome coated glass that will not fog or discolor and is adjustable.

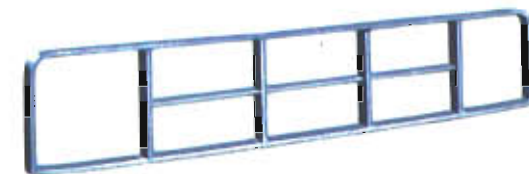

**COMMERCIAL GRILLE GUARD**

Commonly known as a brush or military type guard.



**PICK-UP SIDE RAILS**

Serve as tie-downs for large cartons or cargo to prevent shifting.



**PICK-UP SIDE STEP**

Permits easy access to the cargo in the front load space.

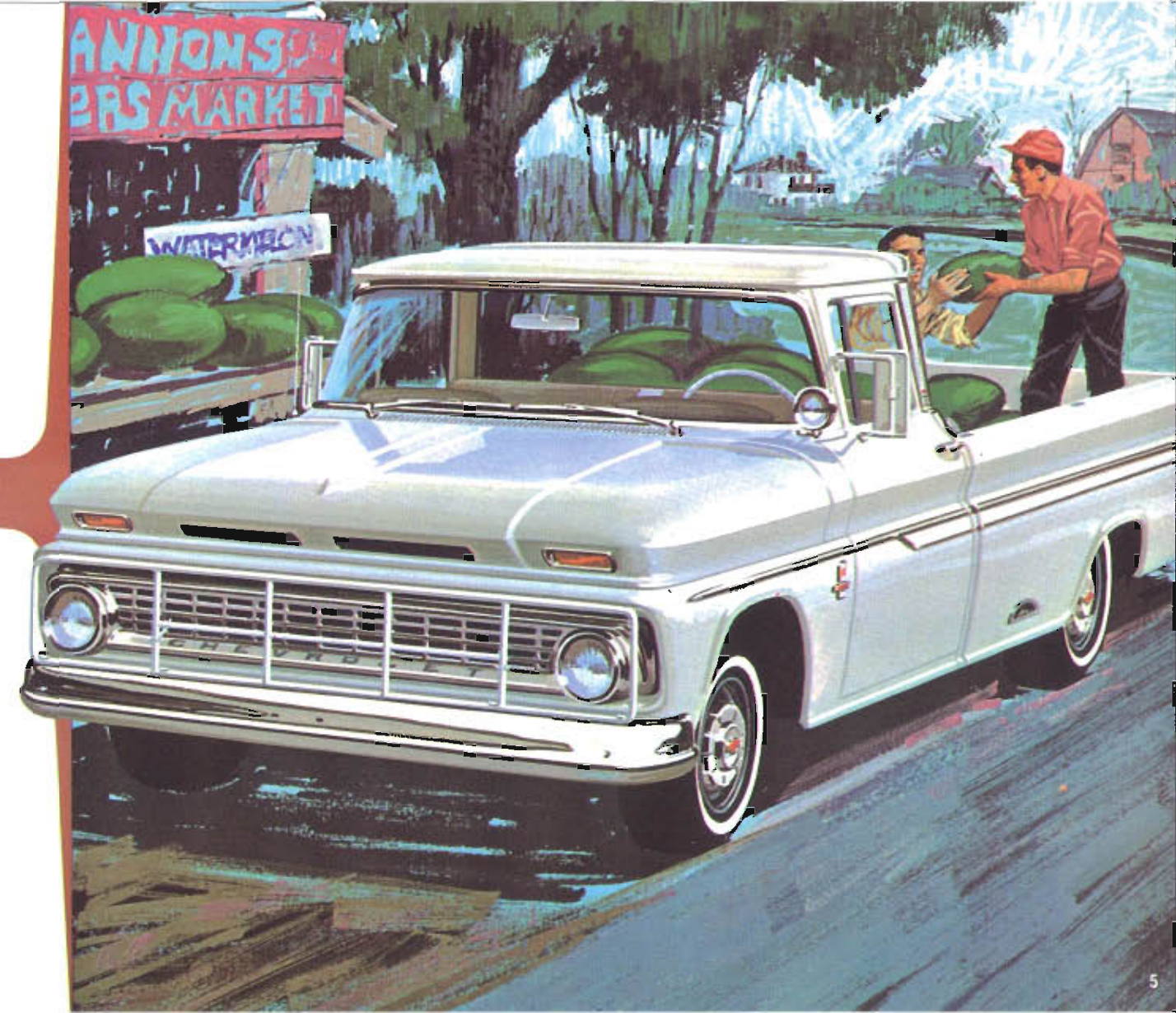

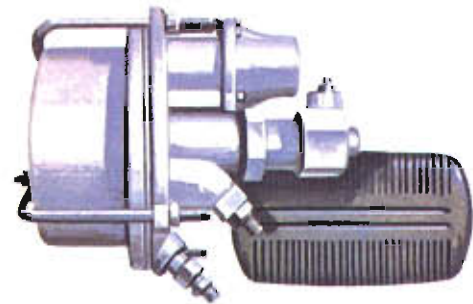

**POWER BRAKE**

A low pedal type power brake for all one half to one ton trucks.



**CHROME**

**PAINTED**

**FRONT BUMPER GUARDS**

Spring steel guards either painted or chrome to match bumper face bar.



**RADIO AND ANTENNA**

A modern all transistor radio that starts to play instantly.



**BACK-UP LAMPS**

Automatically provides light to the rear of the vehicle when shifted into reverse.

**CUSTOM FEATURE ACCESSORIES FOR CHEVROLET PICK-UPS**



**RIGHT OR LEFT HAND REAR VIEW MIRRORS**

A 7½ x 10½ inch mirror with chrome coated glass that will not fog or discolor and is adjustable.



**COMMERCIAL GRILLE GUARD**

Commonly known as a brush or military type guard.



**PICK-UP SIDE RAILS**

Serve as tie-downs for large cartons or cargo to prevent shifting.



**PICK-UP SIDE STEP**

Permits easy access to the cargo in the front load space.

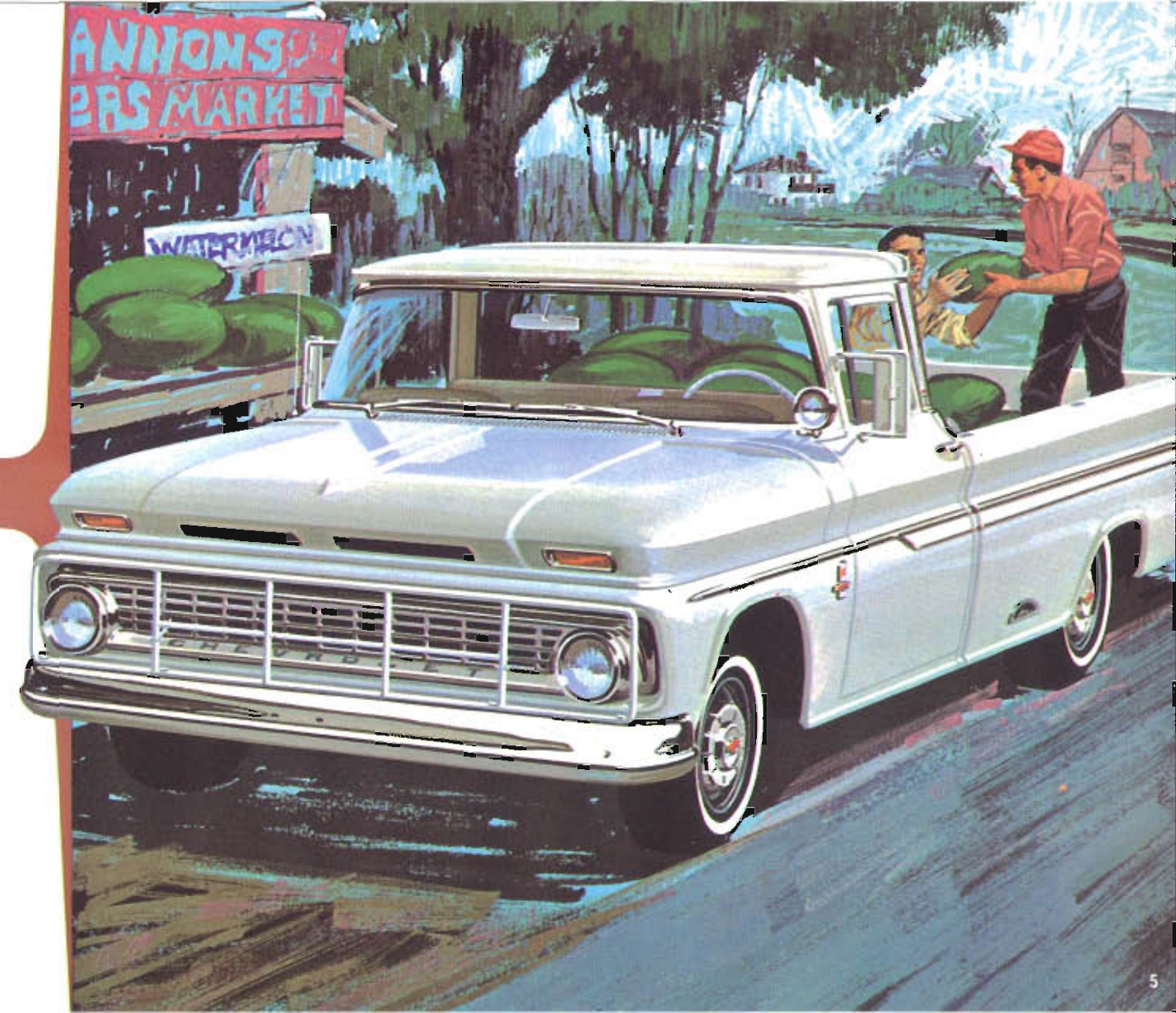

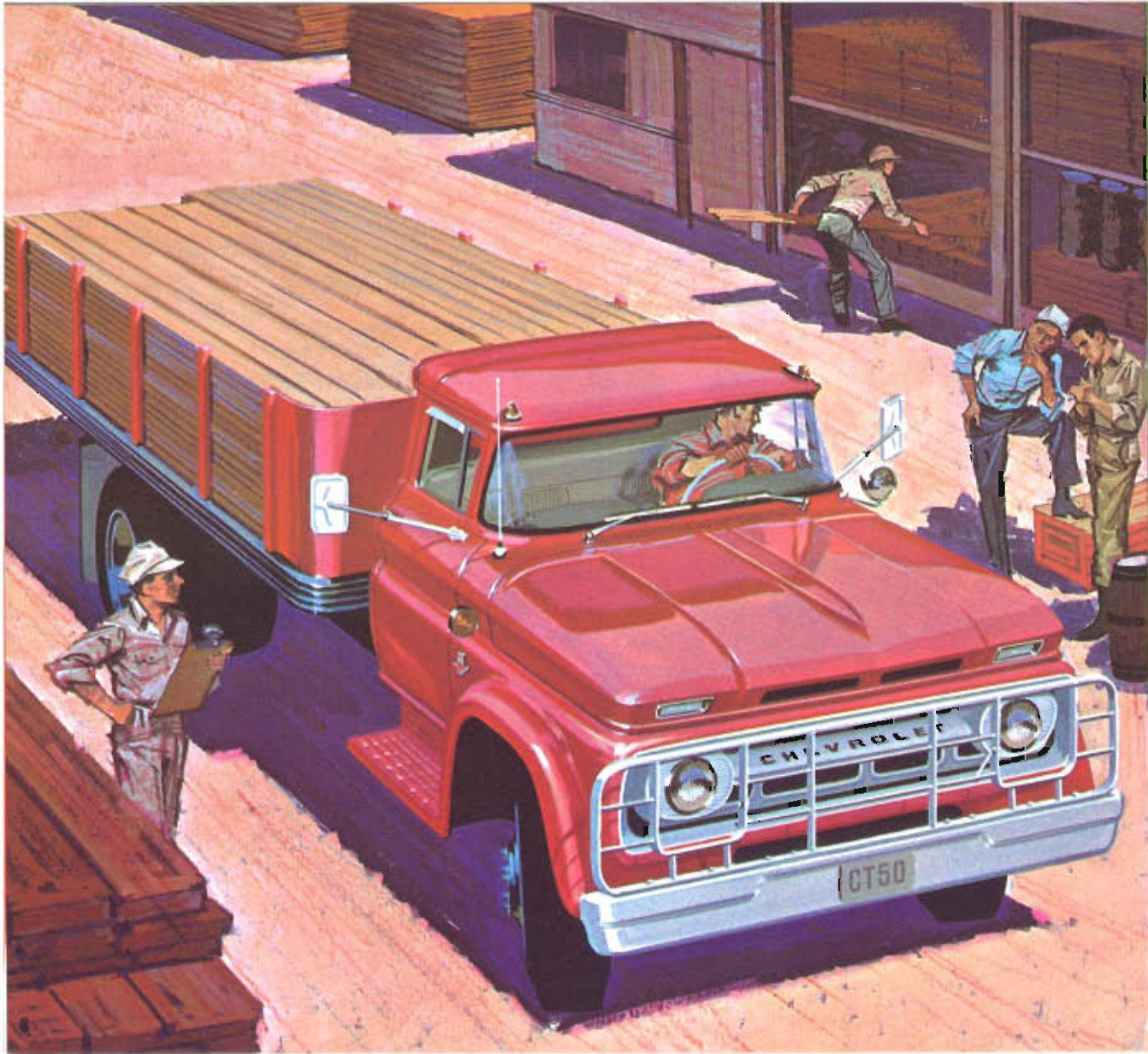

**CAB CLEARANCE LAMPS**  
A streamlined lamp that can be installed on each corner or in the center of the cab roof.



**RADIO AND ANTENNA**  
An all transistor radio that starts to play instantly.



**SEAT COVER**  
A high quality fiber seat cover bound with heavy gauge clear plastic trim.

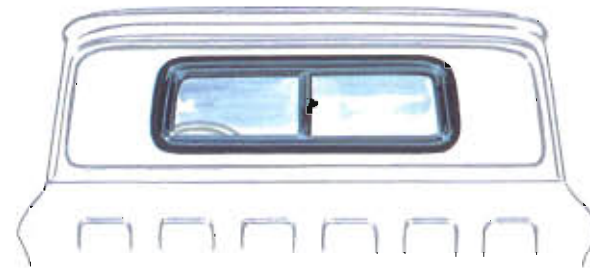

**SLIDING REAR CAB WINDOW**  
Replaces regular rear cab window and permits the window to be opened.

## CHEVROLET CUSTOM

## FEATURE ACCESSORIES FOR ALL STANDARD AND DELUXE CABS



**SAFETYLIGHT**  
Casts a powerful beam of light up to 1500 feet in any direction.

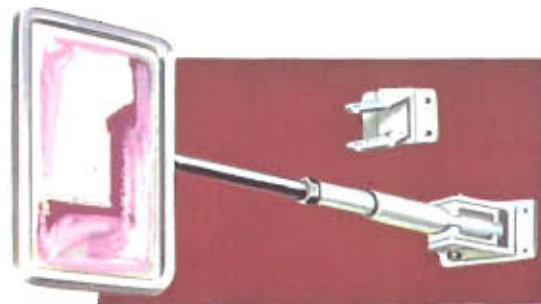

**EXTENDABLE REAR VIEW MIRROR**  
A 5 x 7 inch mirror with an adjustable arm that can be extended from 12 to 20 inches.



**SEAT BELTS** — Chevrolet belts meet or exceed all known state and federal specifications.



**RIGHT HAND SUN VISOR**  
Identical in color and size to left hand visor.

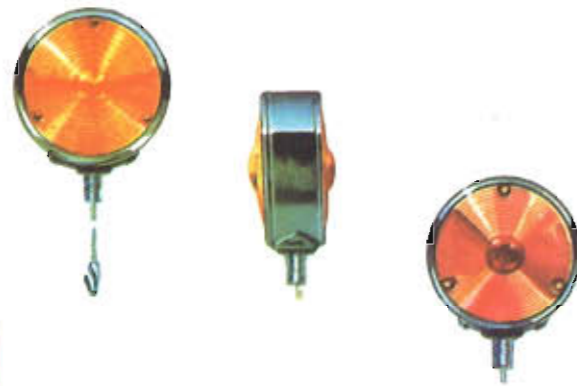

**DIRECTION SIGNAL CONVERSION**  
A unit to convert parking lamps to double face direction signals.



**AUTO COMPASS**  
A dependable compass with an illuminated dial.



**ELECTRIC CLOCK**  
A precision reliable clock with automatic regulation.

## CHEVROLET CUSTOM FEATURE ACCESSORIES FOR CORVAIR 95 TRUCKS



**RADIO AND ANTENNA**  
An all transistor radio that starts to play instantly.

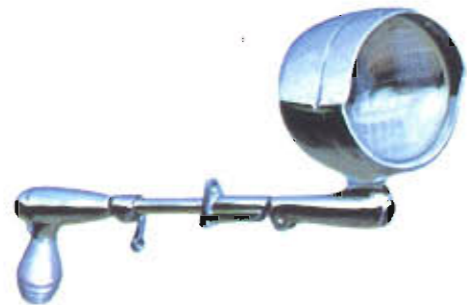

**SAFETYLIGHT**  
A powerful lamp with a rear view mirror in the lamp housing.



**CIGARETTE LIGHTER**  
A lighter with an automatic release when ready for use.



**PUSH BUTTON WINDSHIELD WASHER**  
An electrically operated washer that starts wipers and pump when button is depressed.





**HAND PORTABLE SPOTLAMP**

A 4 inch sealed beam, 12 volt trouble lamp with 12 foot cord.



**LOCKING GASOLINE TANK CAP**

Prevents gasoline from being siphoned from tank without keys.



**RIGHT HAND SUN VISOR**

Identical in color and size to left hand visor.



**ELECTRIC CLOCK**

A precision reliable clock with automatic regulation.

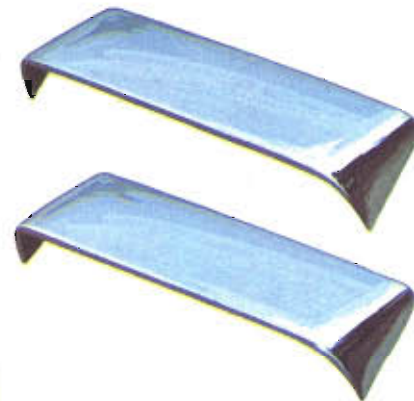

**VENTSHADES**

Provides ventilation on rainy days and reduces window fogging.



**EMERGENCY TOOL KIT**

Tools that will serve in most all minor emergencies.



**ARM REST**

A sturdy vinyl covered arm rest that reduces driving fatigue, and as a door pull to close door.



**DIRECTION SIGNAL CONVERSION**

A unit to convert parking lamps to double face direction signals.

## CHEVROLET CUSTOM FEATURE ACCESSORIES FOR ALL MODEL TRUCKS

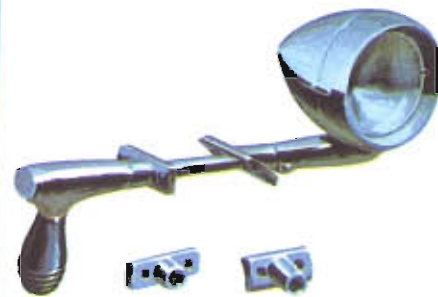

**SAFETYLIGHT**

Casts a powerful beam of light up to 1500 feet in any direction.



**VENTILATED SEAT CUSHION**

A ventilated cushion constructed of flat top springs that will not crush.

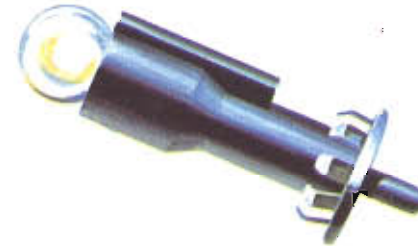

**GLOVE COMPARTMENT LAMP**

Automatically lights when glove compartment door is opened.



**HAZARD FLASHER SWITCH**

An emergency switch to flash all four direction signals simultaneously.



**PUSH BUTTON WINDSHIELD WASHER**

An electrically operated washer that starts wipers and pump when button is depressed.



**DUAL MUD FLAPS AND BRACKETS**  
High tensile reinforcement cords prevents breaking of the rubber.



**RIGHT OR LEFT HAND REAR VIEW MIRROR**  
A large 7 x 16 inch mirror with chrome coated glass that will not fog or discolor and is adjustable.



**MANUAL THROTTLE CONTROL**  
Permits driver to manually adjust throttle to any engine speed.

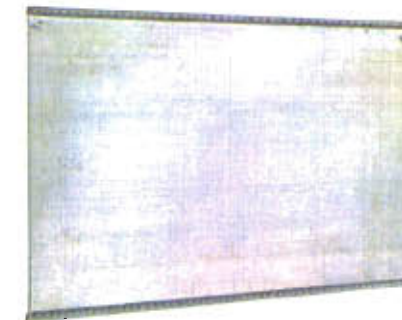

**RADIATOR INSECT SCREEN**  
A fine mesh screen to prevent insects from plugging radiator core.

## CHEVROLET CUSTOM FEATURE ACCESSORIES FOR MEDIUM DUTY TRUCKS



**MATCHED HORN**  
A high note vibrator horn to match the truck low note horn.

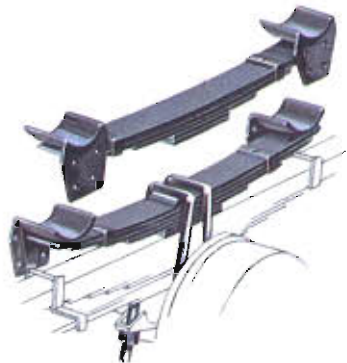

**AUXILIARY REAR SPRINGS**  
Adds more load capacity to the truck.

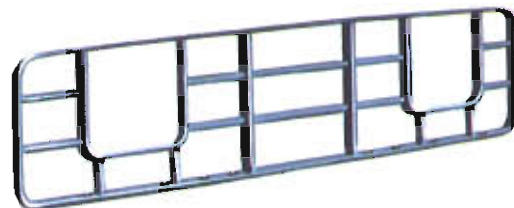

**TRUCK GRILLE GUARD**  
Commonly known as a brush or military type guard.



**ACCELERATOR PEDAL COVER**  
A heavy ribbed non-skid rubber cover with a heel pad.





**CHEVROLET DELUXE**  
**AIR CONDITIONING**  
**FOR LIGHT, MEDIUM**  
**AND HEAVY**  
**CHEVROLET TRUCKS**



**CUSTOM FEATURE ACCESSORIES FOR PANEL TRUCKS**



**LUGGAGE CARRIER**

A permanently attached carrier that adds considerable more cargo space.



**DOMELAMP FOR  
 PANEL TRUCKS**

Lights the entire load area for easy loading at night.



**SEAT BELTS**

Chevrolet belts meet or exceed all known state and federal specifications.

**THE HEART OF ANY  
 AIR CONDITIONER  
 FRIGIDAIRE  
 COMPRESSOR  
 AND CLUTCH  
 ASSEMBLY  
 COMPLETELY  
 FIELD  
 SERVICEABLE**



**CENTER MOUNTING FOR TRUCKS WITH  
 AUTOMATIC OR STEERING COLUMN SHIFT**

An efficient unit for Chevrolet light and medium trucks. The evaporator unit is suspended from the lower edge of the instrument panel and requires only a minimum amount of space, will not interfere with other equipment on truck. Can be installed with or without a heater and defroster.

**FEATURES OF CHEVROLET TRUCK  
 AIR CONDITIONERS**

- Engineered to match Chevrolet engine economy and efficiency.
- Removes up to one and one quarter gallons of moisture from the air an hour.
- Removes dust and pollen from the air and

**RIGHT HAND MOUNTING FOR TRUCKS  
 WITH GEARSHIFT IN FLOOR OF CAB**

This installation is designed for medium and heavy duty trucks with four or five speed transmissions. The installation will not interfere with other optional equipment required on the truck. Can be installed with or without a heater and defroster.

recirculates the air more than once each minute.

- Cooling capacity equal to 2800 pounds (1.4 tons) of ice per day.
- Cools efficiently in city or highway driving.
- Requires virtually no additional labor when servicing the engine.

**CHEVROLET  
CUSTOM FEATURE  
ACCESSORIES  
TO COMPLY WITH  
STATE AND  
FEDERAL LAWS**



**REFLEX REFLECTORS**  
One piece aluminum weather tight three inch reflectors.



**WARNING FLAGS**  
12 x 12 inch tubfast percale flags and staffs that meet I.C.C. specifications.



**EMERGENCY SAFETY KIT**  
Unit consists of three each, oil burning flares, fuses and flags with U.L. and I.C.C. approval.

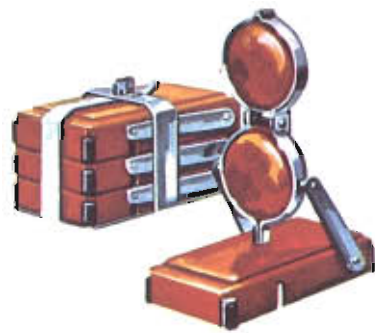

**FLARE REFLECTORS**  
Three double flares in a rattle-free holder that meets state and I.C.C. requirements.

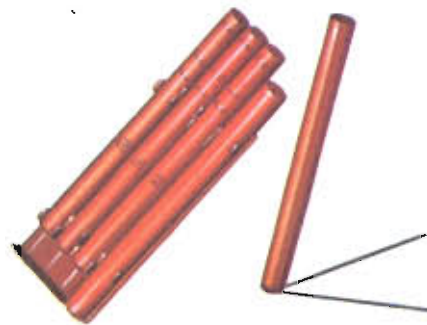

**FUSEE FLARES**  
Wire base type that meet Bureau of Explosives, U.L. state and I.C.C. specifications.



**FIRE EXTINGUISHER**  
U.L. rated for liquid and electrical fires, meets I.C.C. and U.S. Coast Guard regulations.



**SPARE BULB CONTAINER**  
Provision to carry an entire supply of bulbs and sealed beam units.

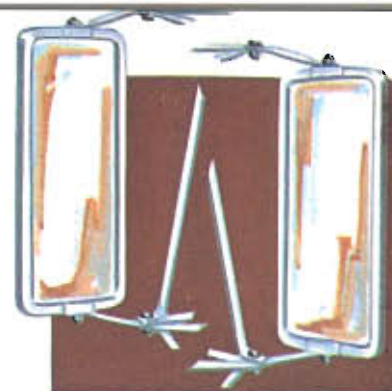

**RIGHT OR LEFT HAND  
REAR VIEW MIRROR**

A 7 x 16 inch mirror with chrome coated glass that will not fog or discolor and is adjustable.



**RIGHT HAND SUN VISOR**

Identical in color and size to left hand visor.

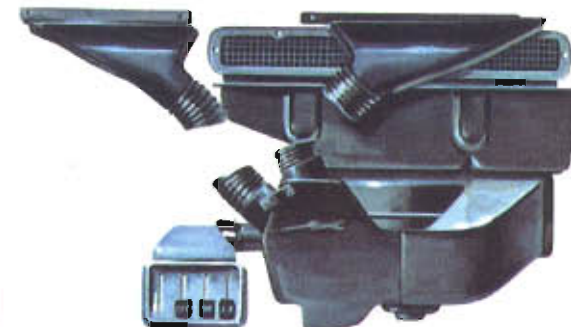

**DELUXE HEATER AND DEFROSTER**

A heating and ventilating system that can be used with outside, recirculated air or a mixture of both.

**CUSTOM FEATURE ACCESSORIES FOR HEAVY-DUTY TILT CAB TRUCKS**



**PUSH BUTTON WINDSHIELD  
WASHER**

An electrically operated washer that starts wipers and pump when button is depressed.



**AIR HORNS**

Can be installed on any truck equipped with air brakes.



**RADIO AND ANTENNA**

A modern all-transistor radio that starts to play instantly.

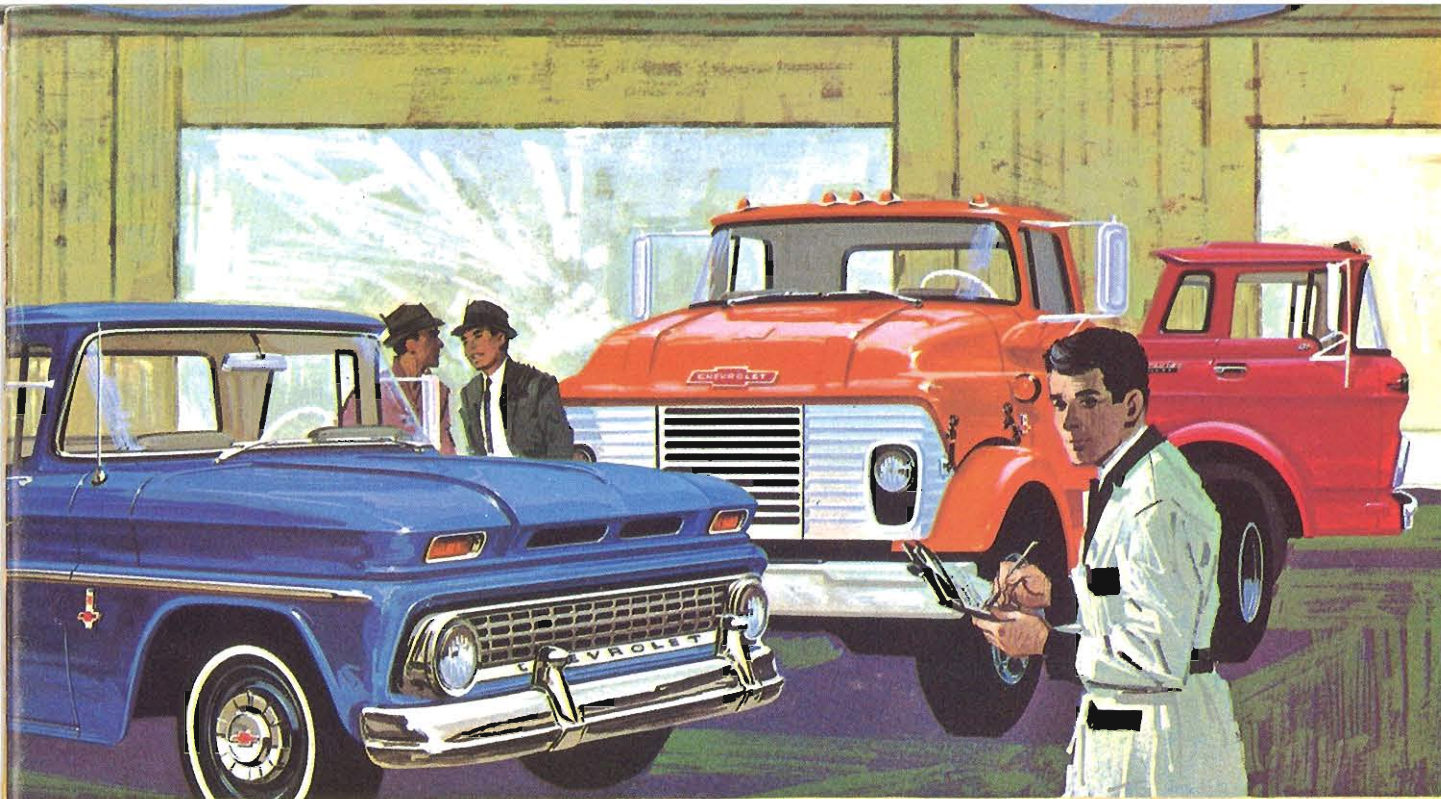

As your friendly Chevrolet truck dealer, we are at your service to assist you with all your truck transportation requirements. Our staff knows Chevrolet trucks best and offers prompt, courteous attention at all times.

**MAY WE SERVE  
YOU SOON  
FOR ALL YOUR  
TRANSPORTATION NEEDS**

We can help you get the right truck to fit your hauling requirements, equipped to give the best service at the lowest cost per mile. We extend a cordial invitation to make our dealership your headquarters for all your transportation needs.