

CORVAIR 95 MODELS

# 1964 CHEVROLET TRUCKS



CHEVROLET

# Corvan

Here's a modern van design that combines ease of handling, good looks and a large easily accessible cargo space that makes every haul easier, more profitable. There's 191 cubic feet of load space with the main cargo volume cradled between front and rear wheels to give well balanced weight distribution and easy handling whether traveling empty or carrying a full 1,700-lb. payload. With a 95-inch wheelbase and a rear-mounted engine, there's excellent maneuverability and outstanding traction on every type of road in all kinds of weather. Large double side doors open up to a load floor just 16 inches off the ground to ease the loading of heavy or bulky cargo. And there's the added convenience of wide-opening double rear doors. Large safety-glass windows are available at small extra cost for the rear doors.

*For all-around load accessibility you can choose the extra-cost left-side loading doors (same size as those on the right) to make your Corvan a more efficient, more profitable truck in every type of delivery service.*

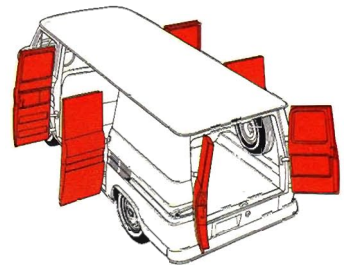

© 1963—Chevrolet Motor Division, General Motors Corporation



# Rampside

This trim-lined rear-engine pickup is designed to take more of the work out of loading and unloading through use of its exclusive side ramp. Double latches are released to allow the ramp to swing down to ground level, forming a rugged loading ramp nearly 4 feet wide to permit rolling heavy loads aboard without lifting. With the floor of the cargo well only 16 inches above the ground, the ramp forms an easy loading slope. When closed, the ramp fits flush with the body side panels and is secured by double latches. A conventional tailgate is also furnished for loading at the rear. And with 82 cubic feet of load space, the double-walled pickup body is ideal for handling large bulky cargoes. Rear-engine design offers the plus benefits of superior handling, either empty or loaded, and excellent traction on all road surfaces.

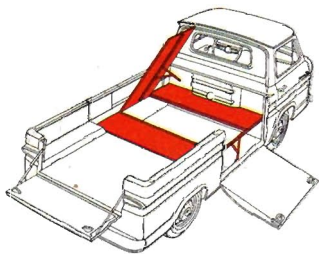

*Extra-cost level load floor adds versatility to the deep cargo well. The level floor offers tailgate-level loading ease plus a protected lower storage area. Sectionalized construction permits partial use for special purposes.*



# Cab Features



*Corvan illustrated with standard driver's seat.*



*Corvan illustrated with extra-cost custom equipment and full-width seat.*

## Standard Interior

Corvaire 95 driver's compartment offers plenty of comfort, easy entry and unexcelled visibility through the broad curved windshield. Deep-cushioned seats full-width in Rampside (driver only in Corvan) feature durable easy-to-clean vinyl upholstery. Standard appointments include driver's sunshade, key locks on both doors, heavy rubber floor mat, dome light, locking dispatch box door and hooded non-glare instrument panel. Extra-cost options for Corvan include auxiliary passenger seat or full-width seat.

## Interior with Custom Option

Extra-cost custom option offers extra luxury. Seat has added comfort with a foam pad in the backrest, and is upholstered in a handsome nylon fabric trimmed with vinyl in red or beige, depending on exterior color. Full-width seat is standard in Rampside, optional at extra cost in Corvan. Custom option includes a driver's armrest, cigarette lighter, passenger's sunshade, white trim on doors, two-tone steering wheel and trim plate on dispatch box door. Extra-cost auxiliary passenger seat is also offered for the Corvan.

## Custom Feature Accessories



In addition to Chevrolet's full range of factory-installed optional equipment, there's a wide variety of dealer-installed Custom Feature accessories available. It's easy to custom-tailor your Corvaire 95 to your own special needs and preferences by choosing from items such as bumper guards, clock, spotlight, special mirrors, seat belts and tool kit. Ask your Chevrolet dealer for full details about the many Custom Feature accessories he offers.

# Body Features



## All-Welded Untitized Construction

Here's efficient design which combines high-strength low-weight construction with top cargo carrying capacity. A rigid frame-and-floor assembly takes the place of conventional separate chassis frame and body floor. This eliminates much of the weight of a separate frame, and requires only a fraction of the thickness needed by the frame-plus-floor combination. Thus the drop-center load platform of Corvair 95s is only 16

inches off the ground, yet there's plenty of clearance below. All-steel all-welded front, side and roof panels complete and strengthen the structure. The big saving in weight that results from unit construction is passed along as extra cargo capacity. It's one of the major reasons that Corvair 95 models have such high payload capacities—1,700 lbs. for the Corvan, 1,850 lbs. for the Rampside pickup!



**Rampside Tailgate**—Double-walled construction provides strength and rigidity. Supported in open position by two folding links—fits snugly and locks securely in closed position.



**Rampside Cargo Ramp**—Takes most of the work out of loading heavy, bulky cargo. Ramp is held in place by spring-loaded latches, and securely hinged with full-width piano hinges.



**Corvan Side Doors**—Door checks hold doors at 110° position for loading convenience; also permit full 180° opening. Double-walled construction for greater strength and better appearance.

**Corvan Rear Doors**—Can be held open at 100 or 180 degrees for loading convenience. Double-walled construction. Rear door windows of safety glass available at extra cost.

# Power Teams

Mounted low between the rear wheels are the air-cooled engine and transaxle. Short universal-jointed axle shafts connect the final drive gears to the rear wheels, cutting unsprung weight to a minimum. Engine construction makes liberal use of lightweight alloys to cut dead weight and make cooling more efficient. Teamed with either of two High Torque 164 Six engines is a choice of three transmissions—3-speed or 4-speed Synchro-Mesh or fully automatic Powerglide. Hypoid pinion and ring gear have a ratio of 3.55, and for extra traction control a Positraction differential is available as an extra-cost option.

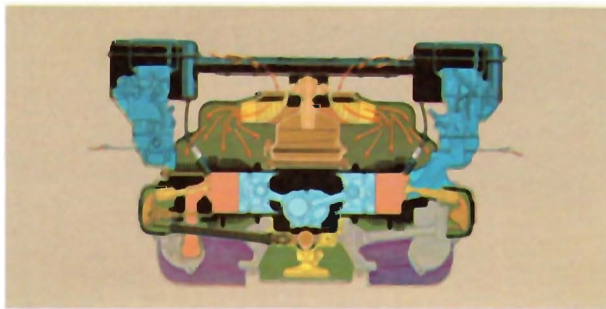

**Forced-Air Cooling** controls engine temperature. A high-capacity blower blasts cooling air between cylinders and through passages in the heads where it picks up heat directly from deep cooling fins. Air supply is thermostatically controlled for fast warm-up and temperature stabilization.

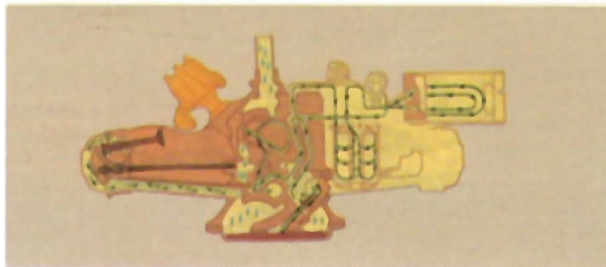

**Full-Pressure Lubrication System** includes full-flow oil filter and oil cooler as standard equipment. An automatic filter bypass valve assures full oil circulation under all conditions, and the cooler is bypassed at low temperatures for faster warm-up. Oil refill capacity is an economical four quarts.

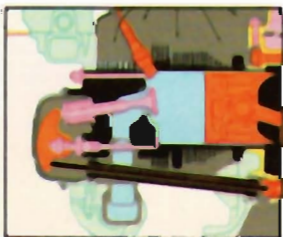

**Precision-Cast Aluminum Alloy Cylinder Heads** have integral fins for efficient cooling. Alloy-steel valve seat inserts, steel exhaust ports and cast iron valve guides prolong engine life. Wedge-type combustion chambers and 8 to 1 compression ratio develop full power on regular-grade fuel.

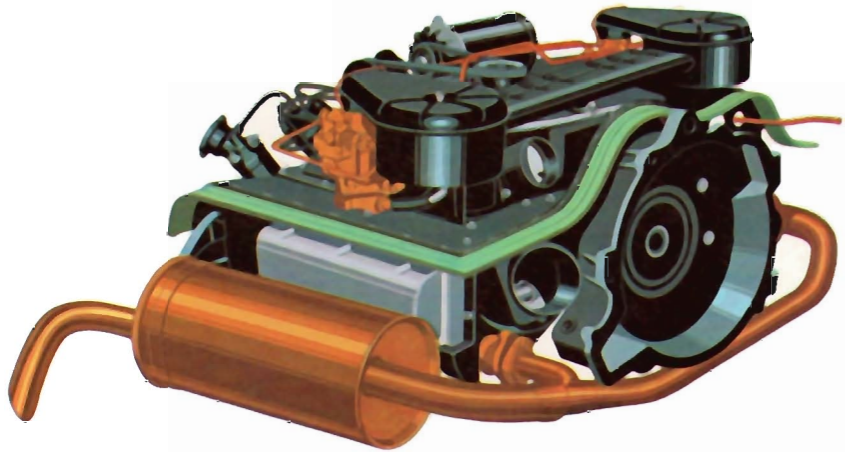

**New High Torque 164 Six** gives high performance, yet keeps fuel consumption low. Modern design with horizontally opposed cylinders makes efficient use of space between rear wheels, and forced-air cooling eliminates ordinary cooling system maintenance and antifreeze expenses. Top durability is assured by features such as new alloy steel crankshaft, new stronger connecting rods, new silichrome steel inlet valves, stellite-faced exhaust valves with automatic rotators and chrome-plated top piston rings. Output is 95 hp. for the standard engine, and 110 hp. for the extra-cost high-lift-camshaft engine.

## Job-Tailored Transmissions

**Three-Speed Synchro-Mesh**, standard on both models, combines compactness with quiet operation and long life. Positive floor shift puts sure control at driver's fingertips. Excellent transmission for general hauling and delivery work.



**Four-Speed Synchro-Mesh** (extra-cost option) is synchronized in all forward speeds for quiet, clash-free shifting. Closely spaced gear ratios harness engine power most effectively to give top performance with maximum payloads.



**Powerglide** (extra-cost option) is a fully automatic two-speed transmission with torque-multiplying hydraulic converter. Ease of control provided by automatic operation is especially desirable for delivery routes involving frequent stop-and-go driving.



# Chassis Features

Front and rear suspensions are attached directly to the chassis platform, which is strongly reinforced by sills and shear plates. The entire underbody is protected against corrosion by a zinc chromate primer, and other areas subjected to moisture, such as wheelhousings, are heavily undercoated. Together with the upper body structure, the chassis platform gives an extremely rigid and durable unitized construction.

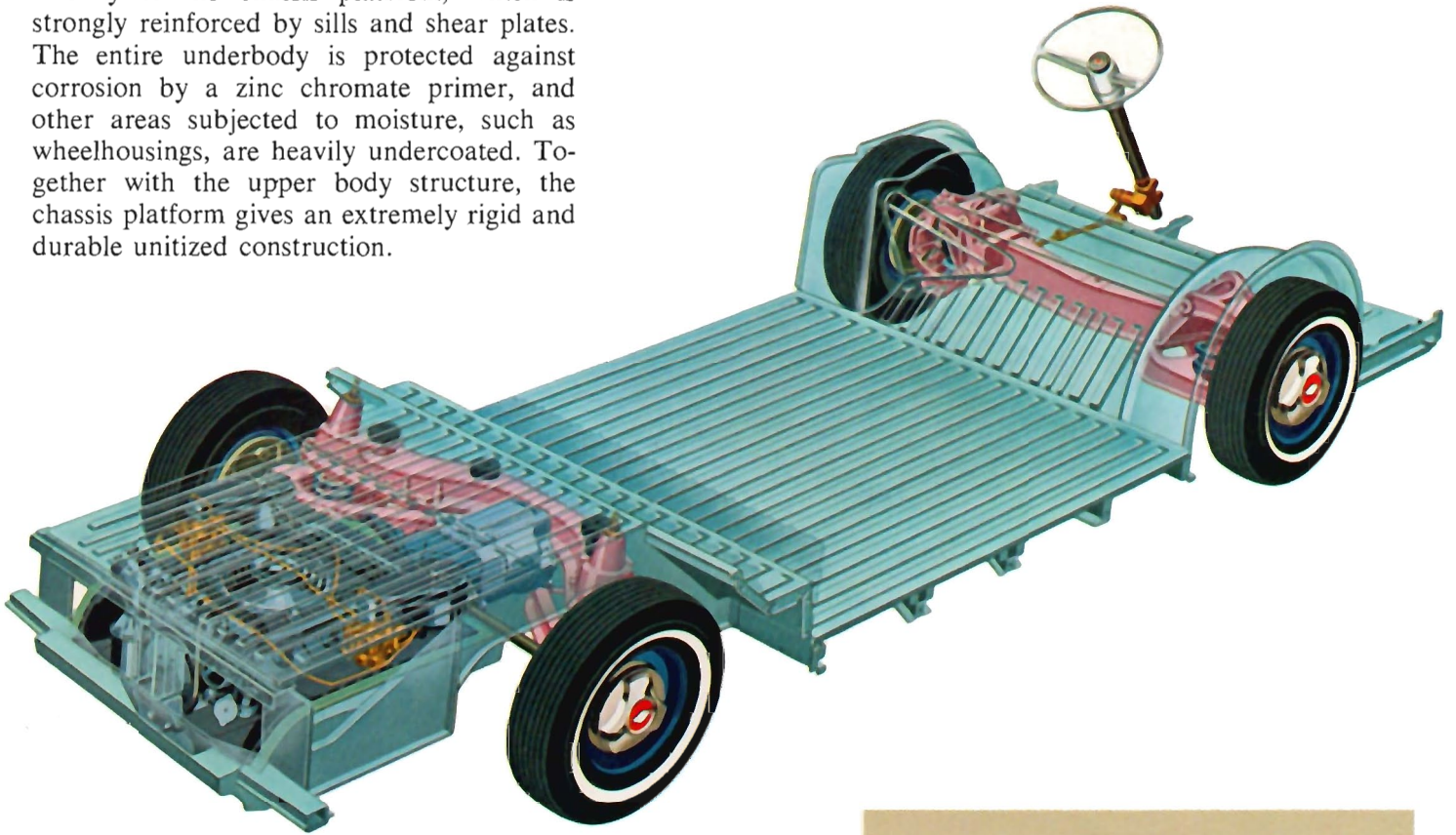

## Four-Wheel Independent Suspension

Specially engineered, the unique Corvair 95s offer incomparable ride and handling thanks to a fully independent 4-wheel suspension system. Front and rear suspension assemblies are built on rugged beams, which give broad-based support to the unitized body frame-floor assembly. Friction-free coil springs at all four wheels offer top load capacity plus smooth, easy ride. Independent rear suspension eliminates much of the weight of a conventional rear axle. Short universal-jointed shafts, needing no heavy housing, connect the wheels with the final drive gearing. With the final drive itself forming a part of the engine-transaxle team, its weight is carried by the springs rather than adding to unsprung weight, so it helps to smooth out the bumps of the road instead of magnifying them.

Heavy-duty front suspension spherical joints minimize friction in steering and ride action, help assure safe, level stops.

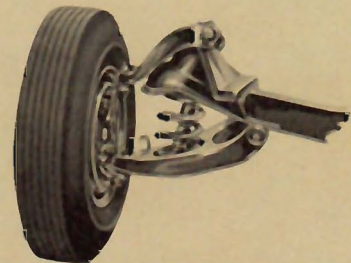

Four-point mounting of rear suspension unit is completely rubber cushioned for maximum protection against shocks and bumps.

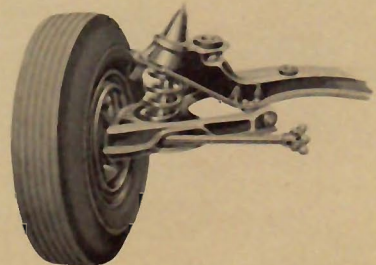

# Specifications

## STANDARD EQUIPMENT

**AXLE, REAR:** Ratio 3.55.  
**BRAKES:** Hydraulic, self-adjusting front & rear 11"x2"; lining area 167 sq. in.  
**CLUTCH:** 9 $\frac{1}{8}$ " diameter.  
**DIRECTIONAL SIGNALS:** Front & rear.  
**ENGINE:** 164 Six; 95 hp; 164-cu.-in. displacement.  
**FUEL TANK:** Capacity 18 $\frac{1}{2}$  gallons.  
**GENERATOR:** 35-amp, normal cut-in.  
**GVW:** 4,600-lb. maximum.  
**SEAT:** Full-width (Rampside); Driver only (Corvan).  
**SPRINGS, FRONT:** Coil, capacity 1,150 lb. each  
**SPRINGS, REAR:** Coil, capacity 1,150 lb. each  
**STEERING:** Ball-Gear, ratio 20.0.  
**SUSPENSION, FRONT:** Independent, capacity 2,500 lb.  
**SUSPENSION, REAR:** Independent, capacity 2,500 lb.  
**TIRES:** Five tubeless 7.00-14/4PR.  
**TRANSMISSION:** 3-speed Synchro-Mesh.  
**WINDSHIELD WIPERS:** Dual electric; single-speed.

## OPTIONAL EQUIPMENT\*

**AXLE, POSITRACTION REAR:** Ratio 3.55.  
**BUMPERS, CHROMED:** Front & rear.  
**CUSTOM EQUIPMENT:** Interior and exterior appearance, comfort and convenience features.  
**DOORS, BODY:** Left side for Corvan model.  
**ENGINE:** 164 Six with special high-lift camshaft (110 hp.).  
**FLOOR, LEVEL PICKUP BOX:** Pickups only.  
**GENERATOR:** 35-amp, low cut-in.  
**HEATER & DEFROSTER**  
**HUB CAPS, CHROMED**  
**PAINT, TWO-TONE EXTERIOR:** Choice of 14 combinations.  
**RADIO:** Manual.  
**SEAT:** (Corvan) Full-width front; right-hand auxiliary passenger seat.  
**TIRES:** (Pass. type) 7.00-14/6PR; 7.00-14/4PR or 6PR whitewall. (Truck type) 7.00-14/6PR or 8PR blackwall only.  
**TRANSMISSIONS:** 4-speed Synchro-Mesh; Powerglide.  
**WINDSHIELD WIPERS:** 2-speed electric (includes washers).

\*Extra cost.

# Dimensions

CORVAN

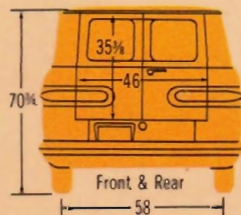

Side Door Opening  
Height 51  
Width 53

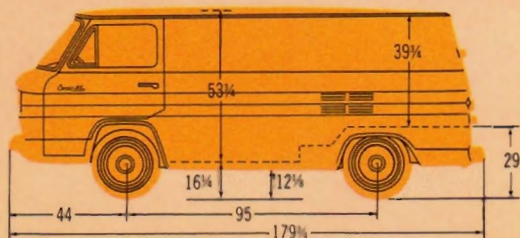
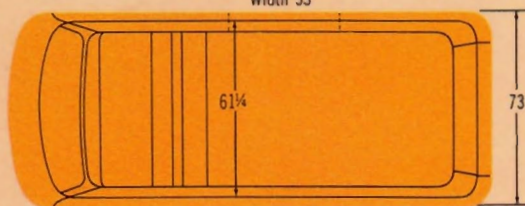

RAMP SIDE

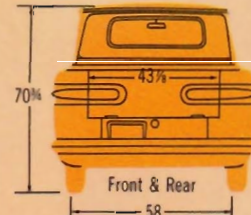

Ramp Door Opening

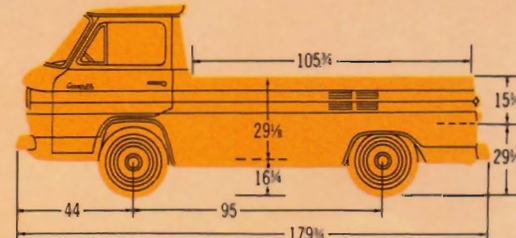
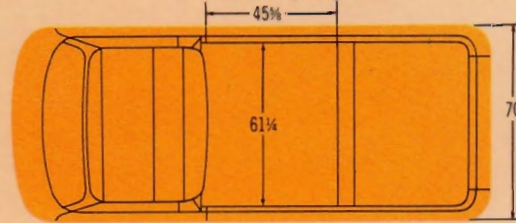

All illustrations and specifications contained in this literature are based on the latest product information available at the time of publication. The right is reserved to make changes at any time in prices, colors, materials, equipment, specifications and models, and also to discontinue models. CHEVROLET MOTOR DIVISION OF GENERAL MOTORS CORPORATION, DETROIT 2, MICHIGAN. Litho in U. S. A.