

HEATERS AND DEFROSTERS

FOR CHEVROLET LIGHT-MEDIUM AND HEAVY TRUCKS

A heating and ventilating system that can be used with outside air, recirculated air or a mixture of both to reduce window fogging on rainy days, to remove smoke and stale air from cab. The high volume air circulation from the three speed blower assures rapid removal of snow and ice from the windshield.

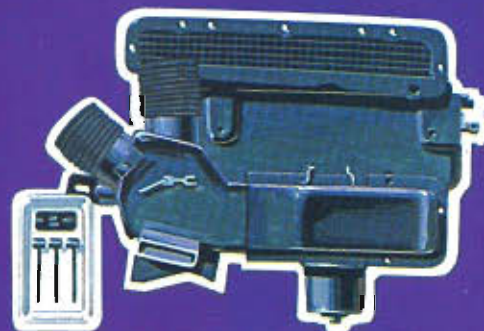

DELUXE HOT WATER HEATER
AND DEFROSTER

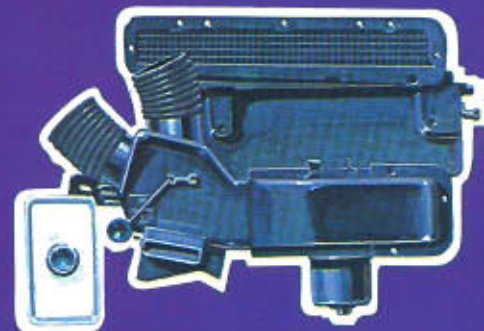

THRIFT-AIR HOT WATER HEATER
AND DEFROSTER

The new THRIFT-AIR HEATER operates on outside air that is heated by a copper heating core. The heated air is circulated and controlled by a three speed centrifugal blower motor. The defroster control lever is located on the air duct within easy reach of the driver. The high capacity air distribution obtained in the heater and defroster system assures comfortable heating and sufficient heat for the defrosters to keep the windshield clear of steam, ice and snow.

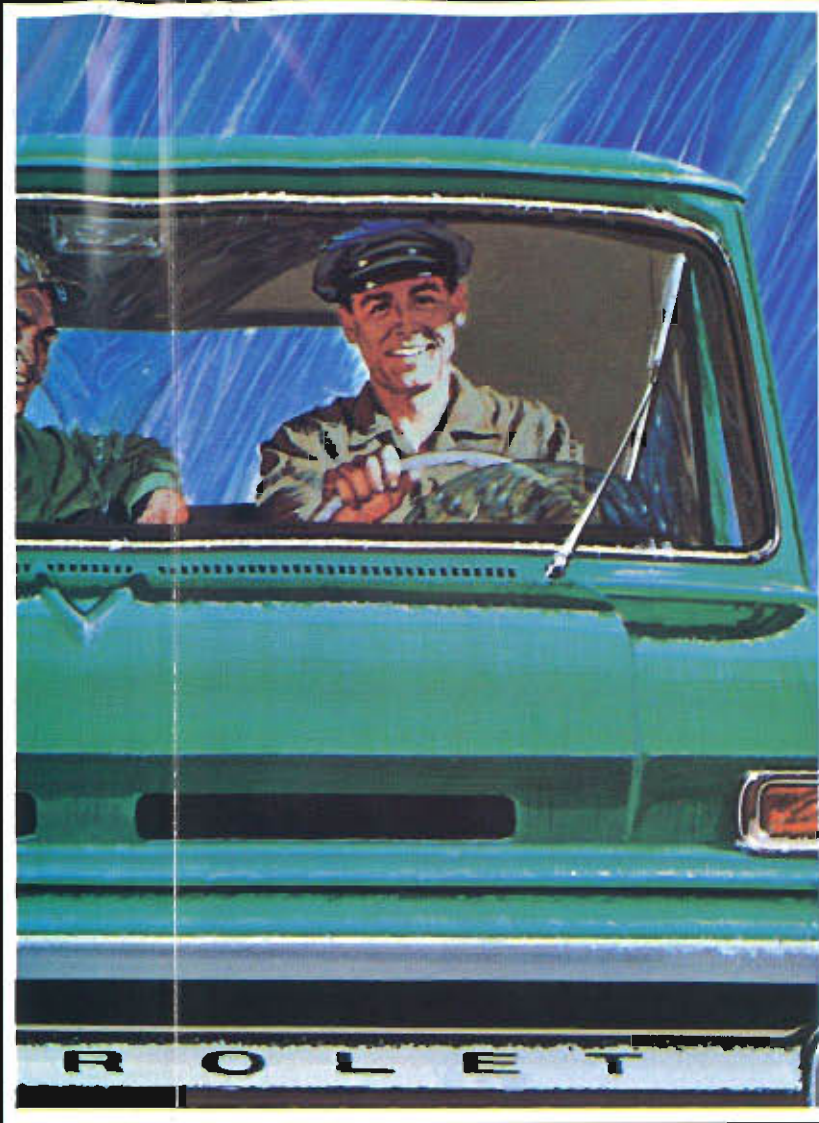

'64 CUSTOM FEATURE ACCESSORIES

FOR ALL CHEVROLET TRUCKS

INDEX	page
CHEVROLET HEATERS AND DEFROSTERS FOR LIGHT, MEDIUM, AND HEAVY TRUCKS	1
CUSTOM FEATURE ACCESSORIES FOR CORVAIR 95 SERIES TRUCKS	2-3-4
CUSTOM FEATURE ACCESSORIES FOR CHEVROLET PICK-UPS AND PANELS	5-6-7
CUSTOM FEATURE ACCESSORIES FOR CHEVELLE EL CAMINO	8-9
CHEVROLET CUSTOM DELUXE AIR CONDITIONING FOR LIGHT, MEDIUM AND HEAVY TRUCKS	10
CHEVROLET CUSTOM FEATURE ACCESSORIES FOR MEDIUM DUTY TRUCKS	11-12-13
CHEVROLET CUSTOM FEATURE ACCESSORIES FOR HEAVY DUTY AND TILT CAB TRUCKS	14-15

All illustrations and specifications in this literature are based on the latest product information available at time of publication. The right is reserved to make changes at any time without notice, in colors, materials, equipment specifications, and models, also to discontinue items or models.

© 1963
CHEVROLET MOTOR DIVISION
GENERAL MOTORS CORPORATION

CHEVROLET MOTOR DIVISION
GENERAL MOTORS CORPORATION
DETROIT 2, MICHIGAN

**CHEVROLET TRUCK ACCESSORIES TO
COMPLY WITH STATE AND FEDERAL LAWS.**





LOCKING GASOLINE CAP
Prevents gasoline from being contaminated or siphoned from tank without keys.

CUSTOM FEATURE ACCESSORIES FOR CORVAIR 95 SERIES TRUCKS



EMERGENCY TOOL KIT
Sufficient hand tools to handle most minor road emergencies.



RIGHT OR LEFT HAND REAR VIEW MIRROR
A 6 x 11 inch mirror with a chrome coated glass that will not fog or discolor.

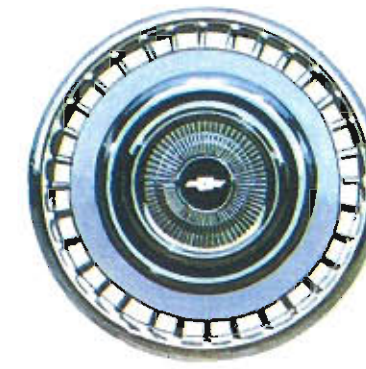

WHEEL COVERS
Stainless steel covers with a chrome flash for a bright attractive finish.



FRONT BUMPER GUARDS
Spring steel guards available with a chrome or painted finish to match bumper face bar.



CUSTOM MANUAL RADIO AND ANTENNA
A modern all transistor radio using the latest radio circuitry, assuring dependable trouble free performance.



SAFETYLIGHT—A powerful lamp that can be used on right or left hand side of vehicle, with a rear view mirror.

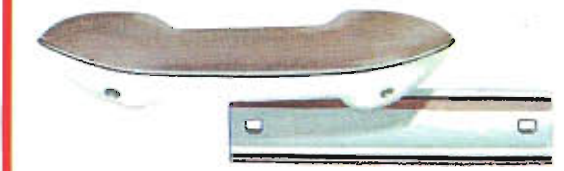

ARM REST AND ADAPTER
A sturdy vinyl covered arm rest, reduces driver fatigue, ideal as a door pull to close door.

HAZARD FLASHER SWITCH
An emergency switch that will flash all direction signals simultaneously.



DELUXE FORCED AIR HEATER AND DEFROSTER

Heater utilizes the engine heat, the air is forced through the ducts by a large centrifugal blower to provide fast heating and defrosting.

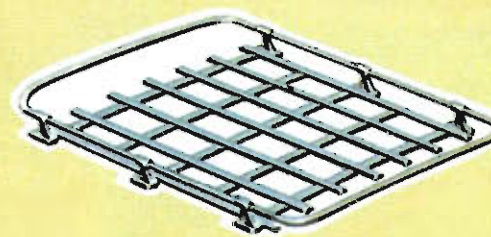
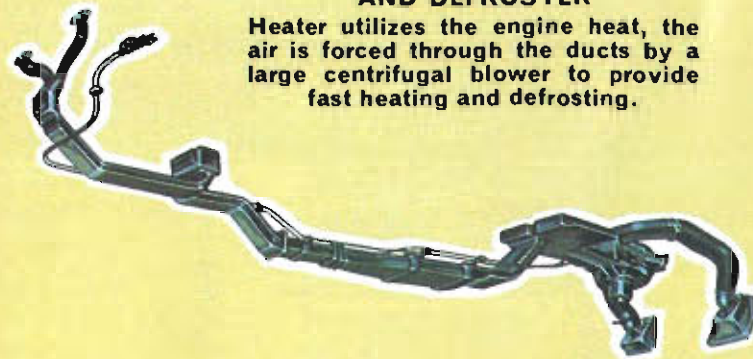

LUGGAGE CARRIER FOR CORVANS
A permanently attached carrier that will add considerably more cargo space.



DOMELAMP FOR CORVANS
Lights entire load area for easy loading at night.



VENTSHADES
Provides additional ventilation to reduce window fogging on rainy days.

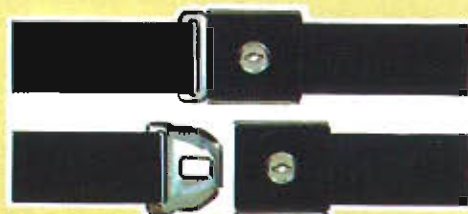

SEAT BELTS—Chevrolet all nylon webbing and forged floor attachments assure greater protection and safety. The metal to metal buckle snaps together easily and stays snapped until released. A flip of the finger releases buckle quickly. The belts are tough, lightweight and comfortable to wear.

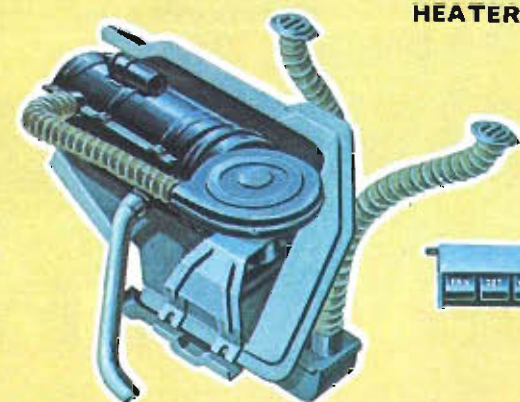

DELUXE GASOLINE HEATER AND DEFROSTER

An aircraft type heater that heats almost instantly, thermostatically controlled to maintain an even heat.





CUSTOM MANUAL RADIO AND ANTENNA
A modern all transistor radio with the latest radio circuitry and reliability not found in "old fashion" hand wired radios.

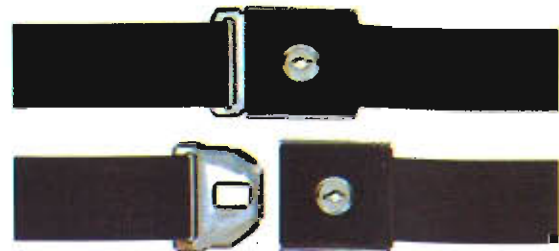

SEAT BELTS—Chevrolet all nylon webbing and forged floor attachments assure greater protection and safety. The metal to metal buckle snaps together easily and stays snapped until released. A flip of the finger releases buckle quickly. The belts are tough, lightweight and comfortable to wear.



RIGHT OR LEFT HAND REAR VIEW MIRRORS
A 7 1/2 X 10 1/2 inch mirror with a chrome coating on the glass that will not fog or discolor.

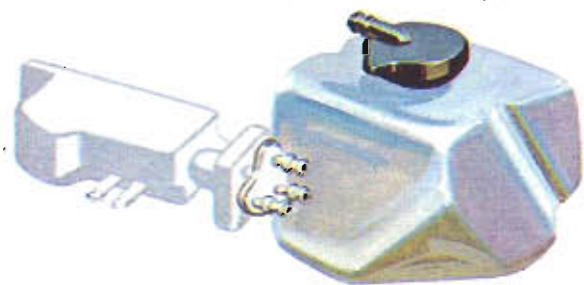

WINDSHIELD WASHER
An electrically operated washer, starts wipers and water pump when button is depressed.

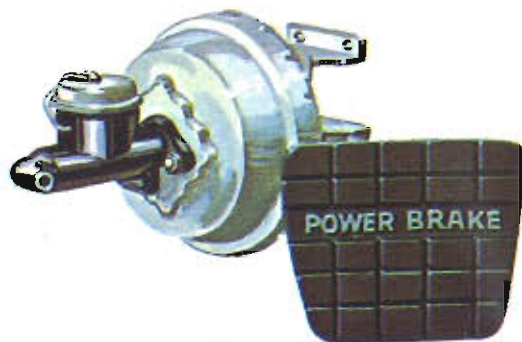

POWER BRAKES
A low pedal type power brake that brings the truck to a smooth, positive stop. Available for all 1/2 to 1 ton trucks.

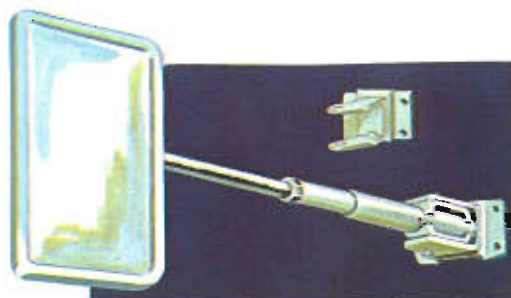

EXTENDABLE REAR VIEW MIRROR
A 5 x 7 inch mirror with chrome coated glass, the extendable arm can be adjusted from 12 to 20 inches. Can be installed on right hand side of truck with the additional right hand bracket.

CUSTOM FEATURE ACCESSORIES FOR PICK-UPS AND PANEL TRUCKS

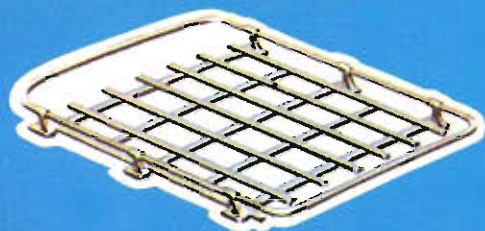

LUGGAGE CARRIER
Permanently attached carrier. Will handle a variety of cargo. A waterproof carrier cover is available.

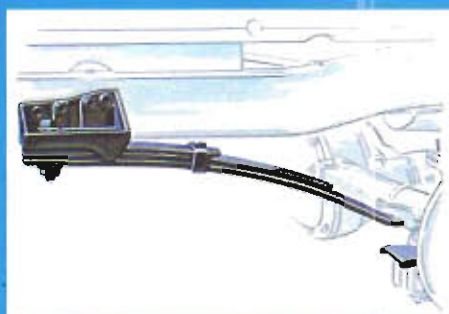

AUXILIARY REAR SPRINGS
Adds more pay load capacity to the pick-up or panel truck.



FRONT BUMPER GUARDS
Spring steel guards available with a chrome or painted finish to match bumper face bar.



COMMERCIAL GRILLE GUARD
Spring steel welded into a rigid one piece guard, securely fasten to the bumper and truck frame.



BACK-UP LAMPS
Provides light to a wide area back of truck automatically when truck is shifted into reverse.

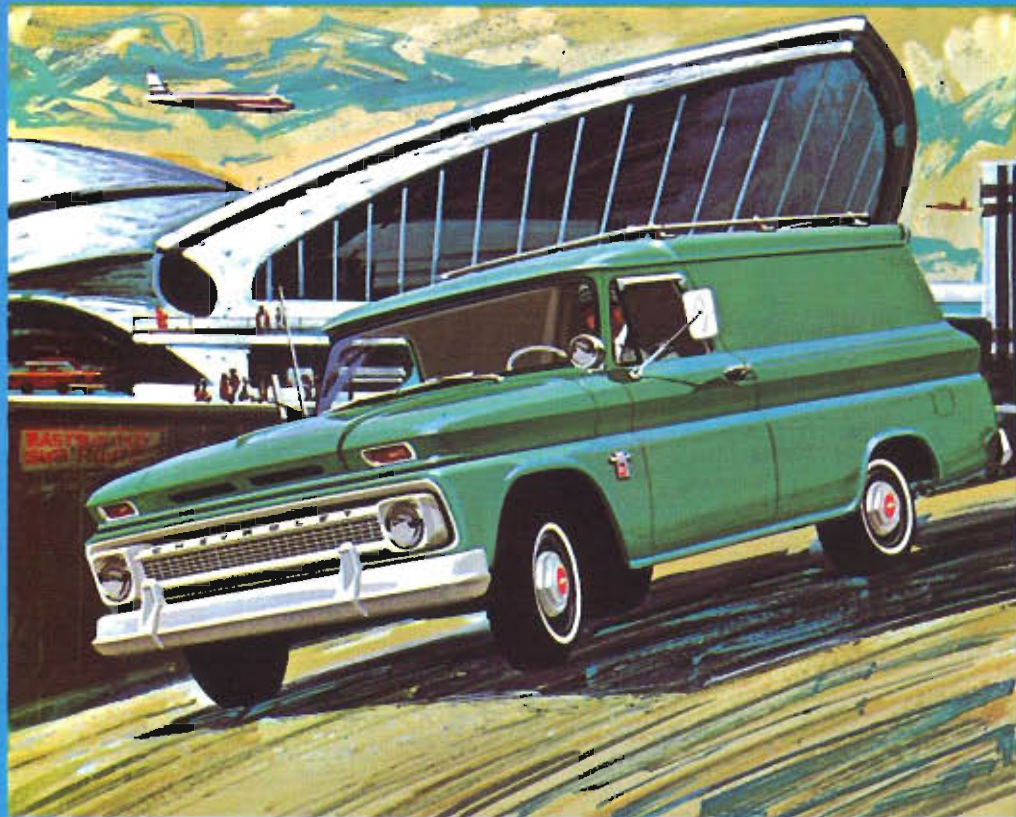

PICK-UP SIDE STEP
Permits easy access to the cargo in the front load space of the pick-up box.



LOCKING GASOLINE CAP
Prevents gasoline from being contaminated or siphoned from the tank without the keys.



DIRECTION SIGNAL CONVERSION
A lamp unit to convert from parking lamps signals to double face direction signals.



MATCHED HORN
A high note vibrator horn to match the production low note, for a strong horn warning.



HAZARD FLASHER SWITCH
An emergency switch that will flash all direction signals simultaneously.

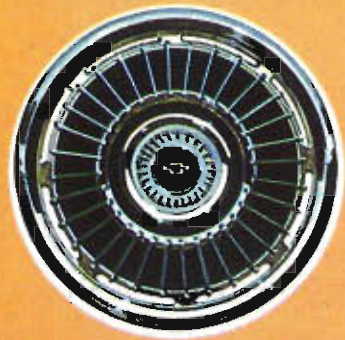

WHEEL COVERS
Stainless steel covers with a chrome flash to retain a bright finish indefinitely.



FRONT BUMPER GUARDS
Spring steel guards with a heavy chrome plating, adds additional protection to the front of the vehicle.

CUSTOM FEATURE ACCESSORIES FOR THE EL CAMINO



DELUXE PUSH BUTTON RADIO AND ANTENNA
An all transistor radio with all the latest advancements in modern circuitry and reliability not found in "old fashion" hand wired radios.



OUTSIDE REAR VIEW MIRROR
A chrome coated mirror glass that will not fog, or discolor, always a clear vision of traffic, to the rear.

SAFETYLIGHT



A sealed beam lamp that casts a bright beam of light up to 1000 feet from the El Camino.



REMOTE CONTROL REAR VIEW MIRROR

Chrome coated mirror glass will not fog or discolor. Mirror can be adjusted to any driving position from inside the El Camino.



CUSTOM AIR CONDITIONER

A factory custom air conditioner that cools efficiently in city traffic or on the highway, with engine operating economy.

FEATURES

- ★ Removes up to 1¼ gallons of moisture from the air per hour.
- ★ No perspiration, damp, wilted or wrinkled clothing.
- ★ Circulates cool, properly de-humidified air free of dust and pollen.
- ★ Cooling capacity of 2800 pounds (1.4 tons) of ice per day.

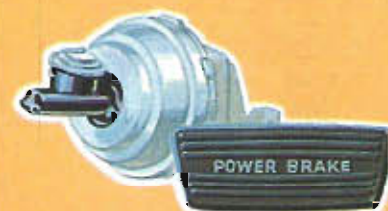

POWER BRAKE

Low pedal brake, about same level as accelerator pedal, for a smooth, positive stop.

CHEVELLE

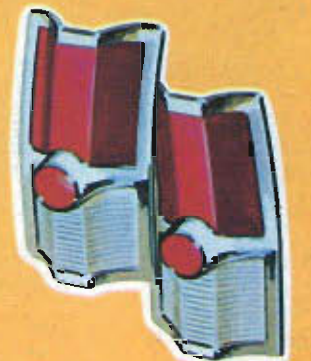

BACK-UP LAMPS

Provides light to a wide area back of vehicle automatically, when El Camino is shifted into reverse.

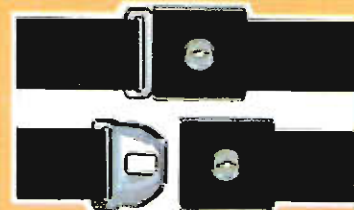

SEAT BELTS

All nylon webbing and forged floor attachments assure greater protection and safety. The metal to metal buckle snaps together easily and stays snapped until released. The belts are tough, lightweight and comfortable to wear.



INSIDE NON-GLARE REAR VIEW MIRROR
A prismatic mirror that can be changed from a clear daytime mirror to a night non-glare mirror.

CHEVROLET CUSTOM AIR CONDITIONING FOR LIGHT-MEDIUM AND HEAVY DUTY TRUCKS



The only factory engineered air conditioner exclusive for trucks. The evaporator unit and air outlets are located in the instrument panel and will not interfere with leg room or other truck equipment.

FEATURES

- ★ Circulates cool, properly de-humidified air free of dust and pollen.
- ★ Operates on either outside air, recirculated air or a mixture of both.
- ★ Cooling capacity equal to 2800 pounds (1.4 tons) of ice per day.
- ★ Engineered to match Chevrolet engine economy and efficiency.
- ★ Requires virtually no additional LABOR when servicing the engine.
- ★ Can be installed with either the DELUXE or THRIFT-AIR heater.

FRIGIDAIRE COMPRESSOR

A six cylinder compressor that is completely field servicable, complete with an electro-magnetic clutch.

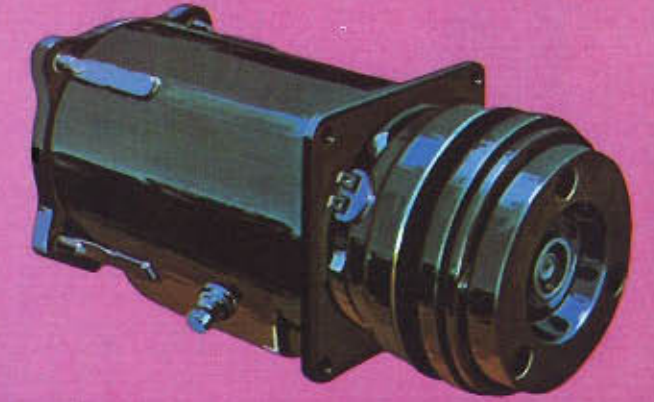

ARM REST

A sturdy vinyl covered arm rest, reduces driver fatigue, ideal as a door pull to close door.

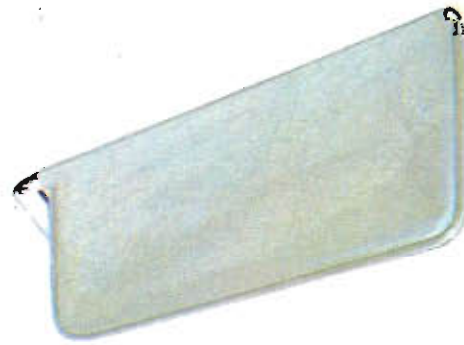

RIGHT HAND SUN VISOR

Identical in size and color to the left hand production visor.



SEAT COVER

A quality fiber seat cover, trimmed with heavy gauge clear plastic. Fits all conventional cabs seats.



INSIDE REAR VIEW MIRROR AND BRACKET—Bracket is mounted in center of cab above windshield, mirror is a prismatic non-glare type, clear in daytime and non-glare at night.



VENTSHADES

Helps prevent window fogging on rainy days by providing additional ventilation in the cab.

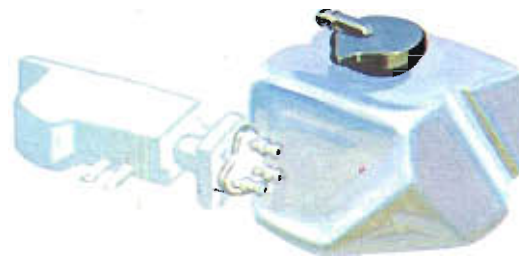

WINDSHIELD WASHER

An electrically operated washer that starts the wipers and water pump, when button is depressed.

CHEVROLET CUSTOM FEATURE ACCESSORIES FOR MEDIUM AND HEAVY DUTY TRUCKS



FIRE EXTINGUISHER

Underwriters Laboratories approved and recommended for flammable liquid and electrical fires.



FIRE EXTINGUISHER RECHARGE KIT—A "Do-it-yourself" kit that anyone can safely recharge the extinguisher in just a few minutes.



MATCHED HORN
A high note vibrator horn to match the production low note for a strong horn warning.



HAZARD FLASHER SWITCH
An emergency switch that will flash all direction signals simultaneously.



EXTENDABLE REAR VIEW MIRROR
A 5 x 7 inch mirror with chrome coated glass, the extendable arm can be adjusted from 12 to 20 inches. Can be installed on right hand side of truck, with additional right hand bracket.

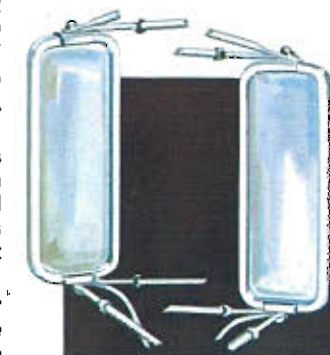

DELUXE RIGHT OR LEFT HAND REAR VIEW MIRRORS
Large 7 x 16 inch mirrors with chrome coated mirror glass that will not fog or discolor. The mirror brackets are adjustable and virtually vibration free.



CAB CLEARANCE LAMPS
A streamlined lamp that can be installed on any Chevrolet cab or panel body roof.



TRUCK GRILLE GUARD
Spring steel welded into a rigid one piece guard, securely fasten to the bumper and truck frame.

AUXILIARY REAR SPRINGS
Adds more pay load capacity to the truck.

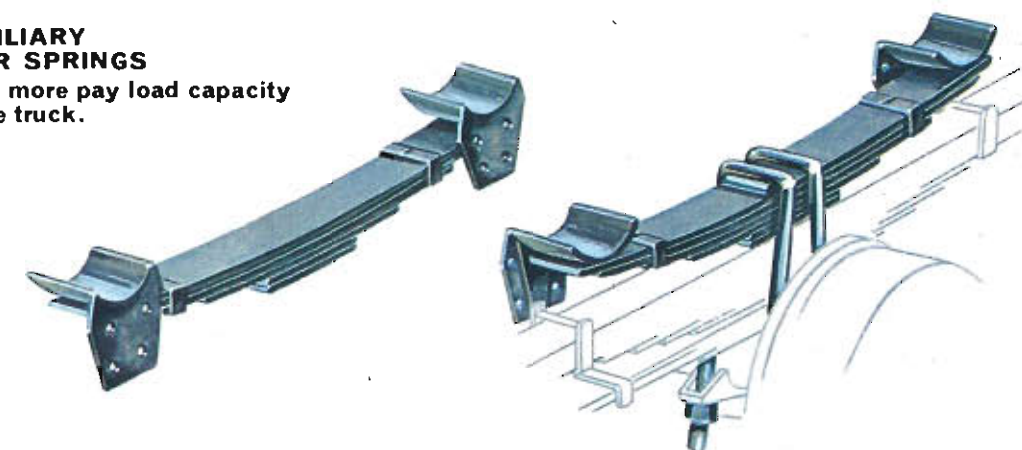

CIGARETTE LIGHTER AND LAMP—Lighter well is lighted when headlamps are turned on for easy replacing of lighter.



GLOVE COMPARTMENT LAMP—Automatically lights glove box when door is opened.



DUAL MUD GUARDS AND BRACKETS
High tensile cord re-inforcements are moulded into the guards to reduce cracking and breaking of rubber.

EMERGENCY TOOL KIT
Sufficient tools to serve in minor road emergencies.



CHEVROLET CUSTOM FEATURE ACCESSORIES FOR MEDIUM AND HEAVY DUTY TRUCKS

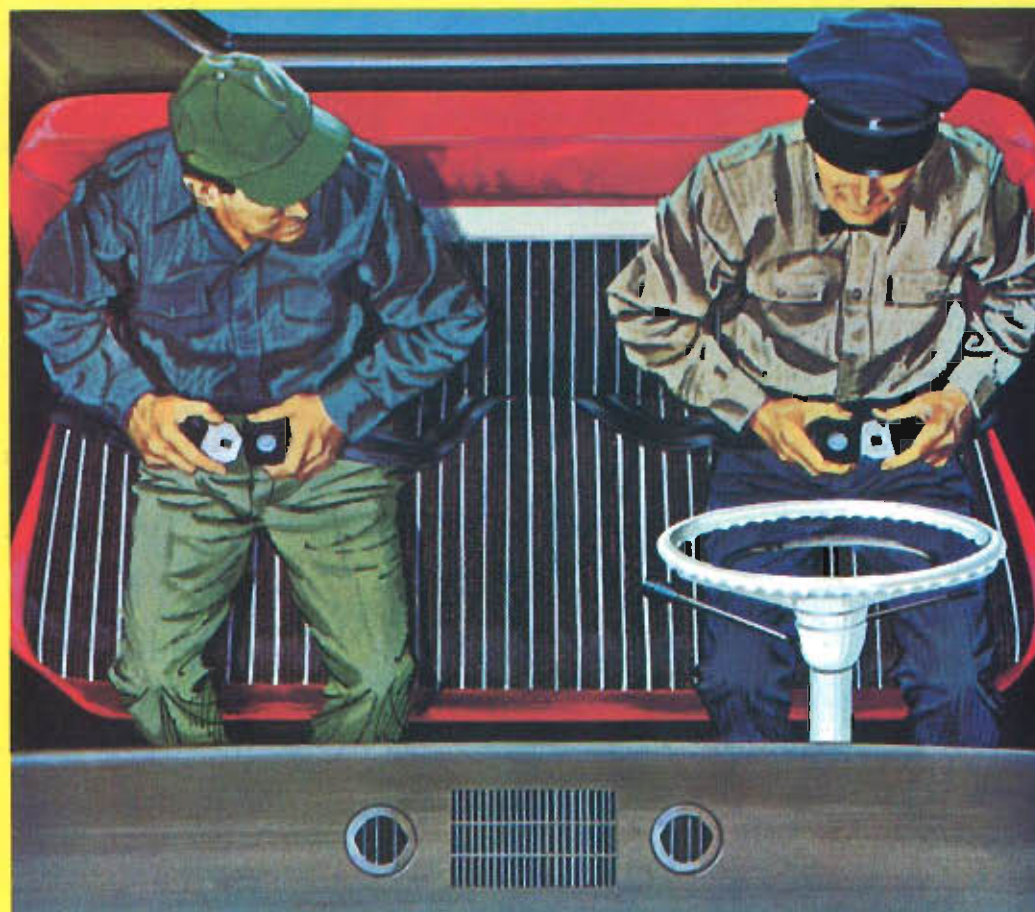

CUSTOM MANUAL RADIO AND ANTENNA—All transistor radio with latest in radio circuitry and reliability not found in "old fashion" hand wired radios.

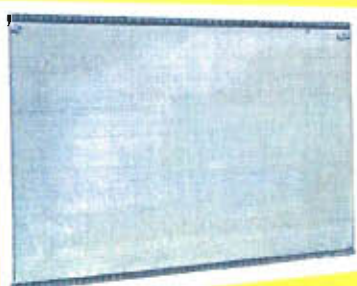

RADIATOR INSECT SCREEN
Prevents radiator core from being plugged with insects and helps maintain proper engine cooling.

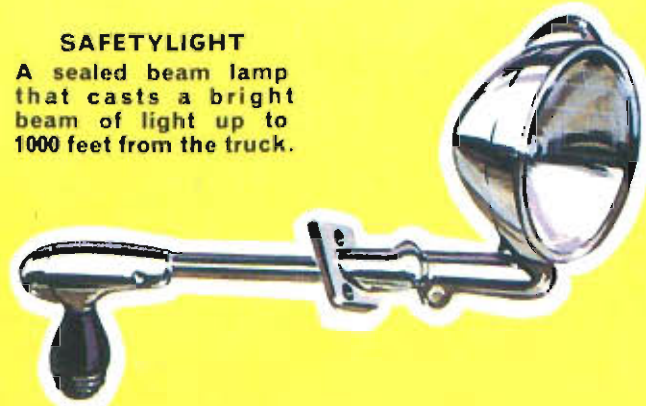

SAFETYLIGHT
A sealed beam lamp that casts a bright beam of light up to 1000 feet from the truck.

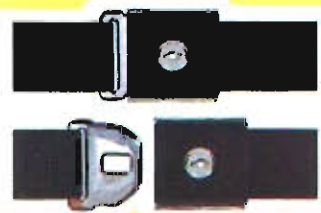

SEAT BELTS
Tough, lightweight seat belts that are comfortable to wear. All nylon webbing and forged hardware assures greater protection and safety.



LOCKING GASOLINE CAP
Prevents gasoline from being contaminated or siphoned from tank without the keys.

**CUSTOM FEATURE ACCESSORIES
FOR HEAVY DUTY TILT CAB TRUCKS**

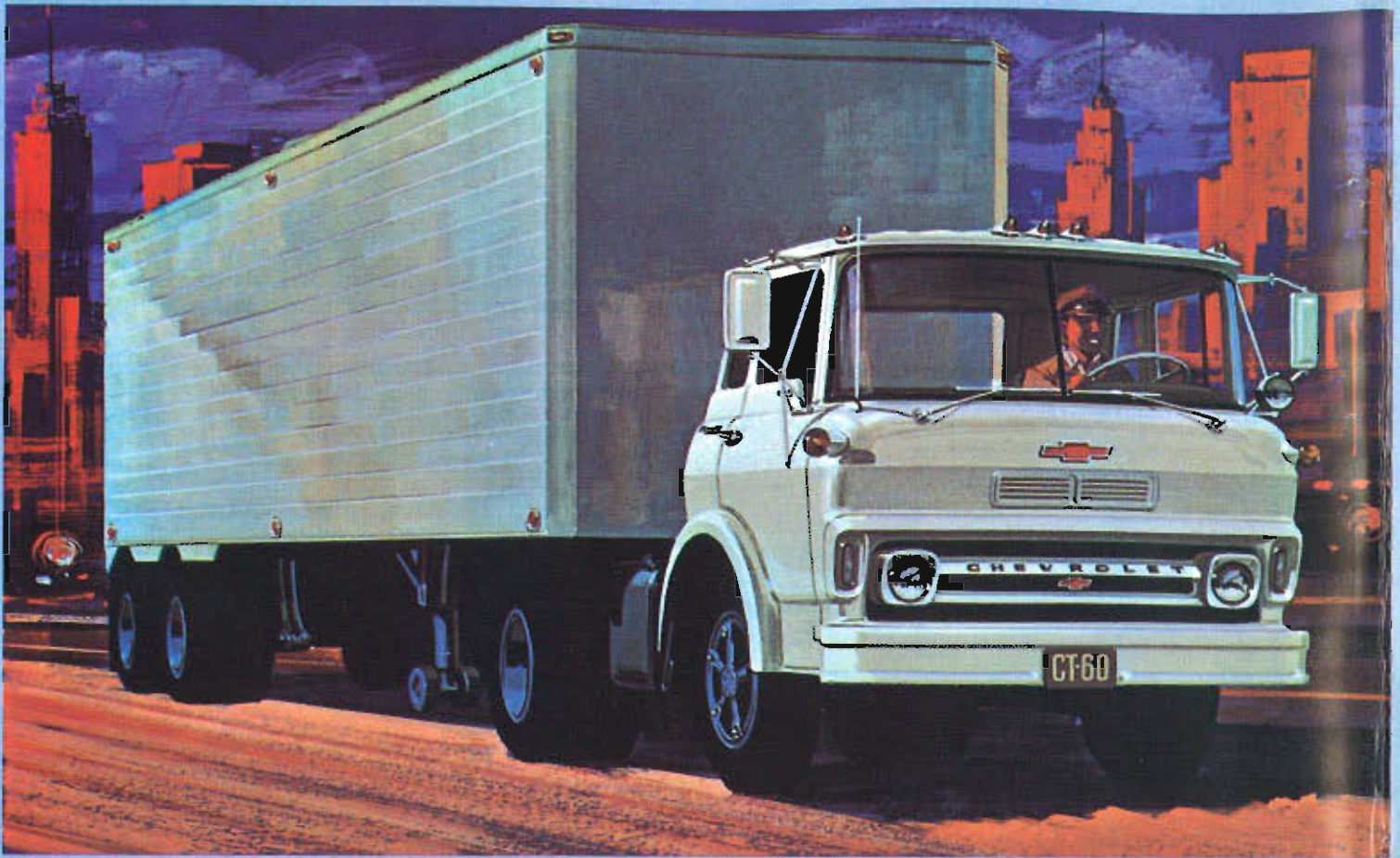

HAND PORTABLE SPOT LAMP
Ideal trouble lamp with 12 foot cord. Can be used in any 12 volt cigarette lighter.

FIRE EXTINGUISHER
Underwriters Laboratories approved and recommended for flammable liquid and electrical fires.

HAZARD FLASHER SWITCH
An emergency switch that will flash all direction signals simultaneously.

CAB CLEARANCE LAMPS
A streamlined lamp that can be installed at outer edges or center of the cab roof.

FIRE EXTINGUISHER RECHARGE KIT—A "Do-it-yourself" kit that anyone can safely recharge the extinguisher in just a few minutes.

AUXILIARY REAR SPRINGS
Add more pay load capacity to the truck.

DELUXE HEATER AND DEFROSTER
A heating and ventilating system that can be used with outside air, recirculated air or a mixture of both.

RIGHT AND LEFT HAND REAR VIEW MIRRORS
Large 7 x 16 inch mirrors with chrome coated mirror glass that will not fog or discolor. The mirror brackets are adjustable and virtually vibration free.



CUSTOM MANUAL RADIO AND ANTENNA—An all transistor radio with the latest in radio circuitry and reliability not found in "old fashion" hand wired radios.

RIGHT HAND SUN VISOR
Identical in size and color to the left hand production visor

SAFETYLIGHT
A sealed beam lamp that casts a bright light up to 1000 feet from the truck.

WINDSHIELD WASHER—An electrically operated washer that starts the wipers and water pump, when the button is depressed.

AIR HORNS
Can be installed on any truck equipped with air brakes.



MAY WE SERVE YOU FOR ALL YOUR TRANSPORTATION NEEDS

As your friendly Chevrolet truck dealer, we are at your service to assist you with all your truck transportation requirements. Our staff of **FACTORY** trained personnel knows Chevrolet trucks best and offers prompt, courteous attention at all times.

**SEE US FOR QUALITY TRUCKS
PROPERLY EQUIPPED FOR THE JOB**

"Portions of materials contained herein have been reprinted with permission of General Motors Corporation, Service Technology Group."

A CHEVROLET TRUCK FOR EVERY JOB

**'64 CUSTOM
FEATURE
ACCESSORIES**

FOR ALL  TRUCKS