

## FOREWORD

This booklet contains a complete review of the discussional slidefilm, Major Collision Damage Repairs on the Corvair.

Each man should have one of these booklets for on-the-job reference, and one copy should be retained in the Service Department file of Technical Information.

## CONTENTS

### PART I

	Page
PRELIMINARY INFORMATION .....	1
BODY ALIGNMENT FUNDAMENTALS .....	3
FUNDAMENTAL METAL DAMAGE .....	3
BASIC STRAIGHTENING METHODS .....	5
SAGGED OR RAISED MEMBER .....	5
SIDESWAY .....	7
TWISTED FLOOR SECTION .....	8
USES OF A TRAM GAUGE .....	9
USES OF CENTERLINE GAUGES .....	10

### PART II

PRACTICAL REPAIR METHODS .....	11
PRELIMINARY STEPS:	
ANALYZING DAMAGE CONDITIONS .....	11
PLANNING REPAIR PROCEDURES .....	13
REPAIR PROCEDURES .....	14

### PRELIMINARY INFORMATION

The repair of major collision damage to the Corvair unitized body has opened up an additional and constantly expanding repair field for the progressive body shop.

**NOW** is the time your dealership should take advantage of the trend toward unitized construction by getting fully prepared with proper training and necessary equipment.

This training film (Part I and Part II) contains practical repair information about major collision damage to the Corvair unitized body with emphasis on misalignment of the unitized lower structure.

### PART I Includes

- BODY ALIGNMENT FUNDAMENTALS
- BASIC STRAIGHTENING METHODS

### PART II Covers

- PRACTICAL REPAIR METHODS

The repair of Corvair collision damage varies from conventional automobiles only when the lower structure is misaligned. Then, panels and structural members must be repaired together to restore alignment.

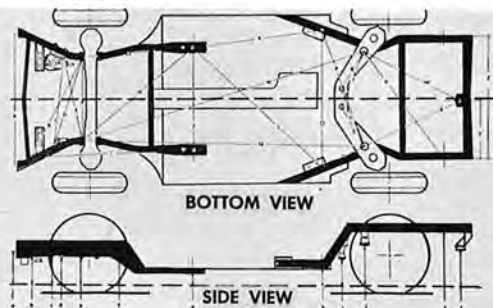

To assist the body repairman, all of the specifications and reference points required to measure structural alignment are contained in the Corvair Shop Manual. Accurate straightening can be accomplished only through following the information given.

New techniques now make it possible for the metal man to do the **EXTRA** and **PROFITABLE** underbody alignment as he repairs the body panels.

This can be done in his own stall without outside assistance.

The result is that delays and subletting of misaligned frames or structural members will be avoided.

## BODY ALIGNMENT FUNDAMENTALS

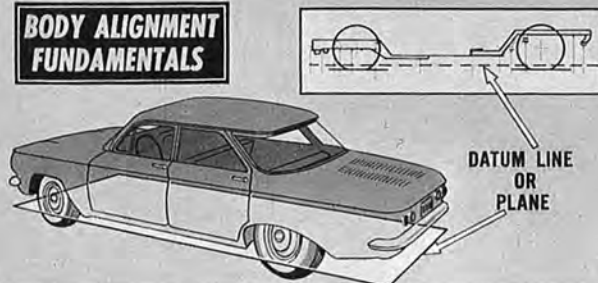

Body alignment measurements are established from two sources. The first of these is the datum line (or plane) of the automobile. The datum line is actually an imaginary plane under the automobile and serves as a reference for all vertical measurements.



To get into this profitable field of body repair requires accurate measuring equipment and a portable frame-straightening machine. Many makes of quality equipment are available; however, only a few representative units can be shown and their use is not intended as a specific recommendation.

CENTERLINE OR PLANE

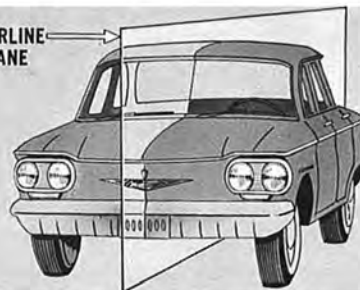

The second measurement source is the centerline. This is an imaginary straight line (or plane) extending lengthwise through the exact center of the automobile. It is the reference for all horizontal measurements. This knowledge must be coupled with a recognition of fundamental metal damage before repairs are started.

Alignment measuring equipment such as a tram, centerline gauges and a steel tape are used on the damaged job as follows:

- |                       |  |
|-----------------------|--|
| <b>BEFORE REPAIRS</b> | —to determine questionable misalignment. |
| <b>DURING REPAIRS</b> | —to insure accurate progress.            |
| <b>AFTER REPAIRS</b>  | —as a final check to determine accuracy. |

The correct use of measuring equipment during repair progress requires a thorough understanding of body alignment fundamentals.

## FUNDAMENTAL METAL DAMAGE



Bends and collapsed sections of structural members are considered as general types of impact damage. Shortened (upset) areas are the primary problem. An upset is found on the inside of any bend as shown, or—

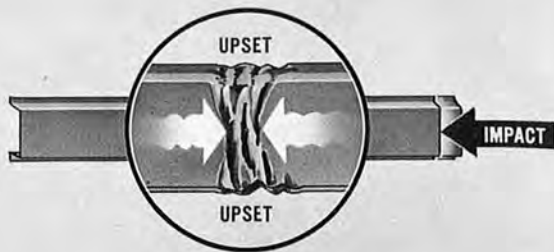

—an upset area will be found on all sides of a member which has been collapsed by straight-line impact.

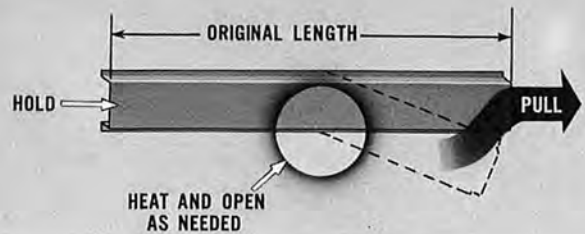

An upset area should be straightened by a pulling force to restore the section to its original length. Heating is often necessary to relieve the work-hardening. Some damaged box members must also be cut open to permit final straightening.

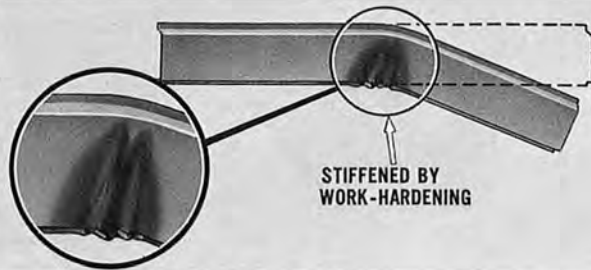

It must also be remembered that metal in a bent or collapsed area is stiffened. This condition is called "work-hardening." It causes the metal to offer greater resistance to straightening than it did to original bending, unless relieved by proper force application, heating, or the use of both.

## BASIC STRAIGHTENING METHODS

Damaged unitized panels and structural members require close visual inspection and measuring to relate the conditions shown previously to the proper straightening procedures. The ability to do this requires a knowledge of these typical damage conditions which are generally a combination of bent or collapsed box members:

- **SAGGED OR RAISED MEMBER**
- **SIDESWAY**
- **TWISTED FLOOR SECTION**

Minor misalignments may spring back due to elasticity of metal, when an adjoining section is straightened.

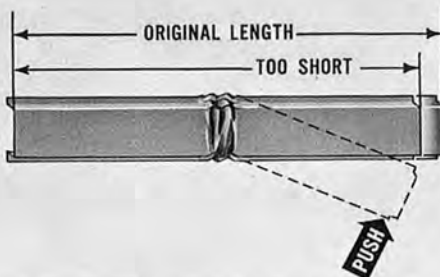

In planning repair procedures, it is important to remember that actual changes of lengths will result, unless the upset, work-hardened metal is relieved during the straightening procedure. If only pushed back to place as shown, the member will tend to be too short.

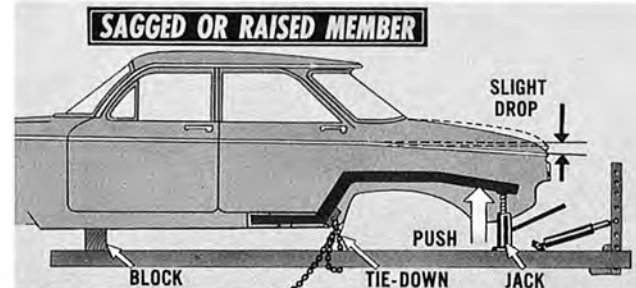

A sagged or raised member is the result of a bend which has permitted a structural member and the connected panels to drop or raise slightly. A minor sag or raise can be pushed up or pulled down into place, using a block, tie-down and jack, to restore alignment and proper length.

A major front or rear end collision causing major structural misalignment requires an over-all length-wise pull to restore proper section alignment.

When this condition is found, the portable frame machine must be used to reverse the effects of heavy impact.

Although the following illustrations are only typical, the basic ideas can be applied anywhere needed.

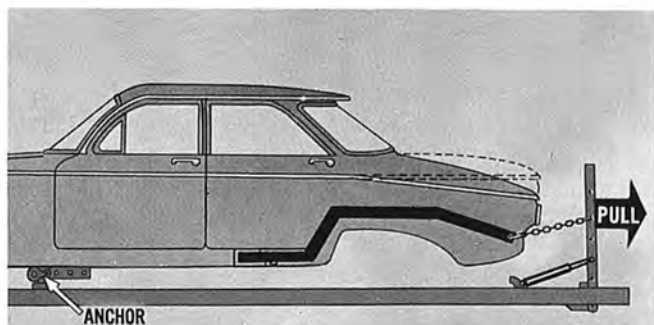

A MAJOR sag or raise in the front or rear end causing extensive buckles, collapses and over-all misalignment usually requires only an over-all straight-line pull. Anchor clamps and a frame machine are used as shown. However —

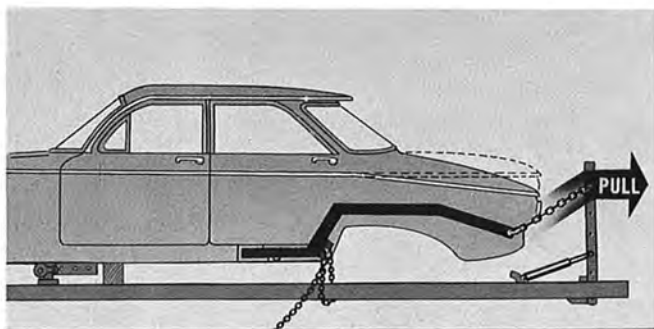

— in some damage conditions the pull may have to be combined with a lifting action to restore proper length and alignment. Tie-downs and support positions are reversed from those shown for a major raise.

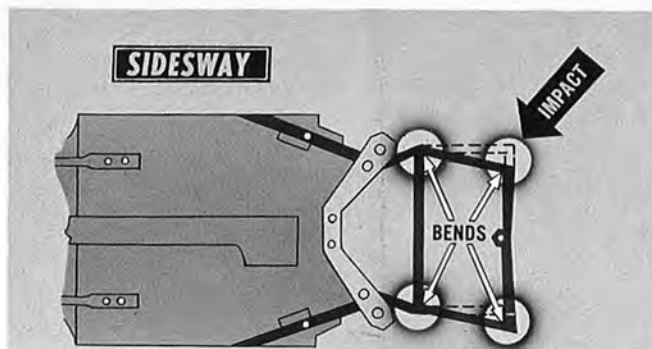

A sidesway is simply a combination of bends and sometimes a collapsed member caused by an impact which permits an entire structural section to move sideways.

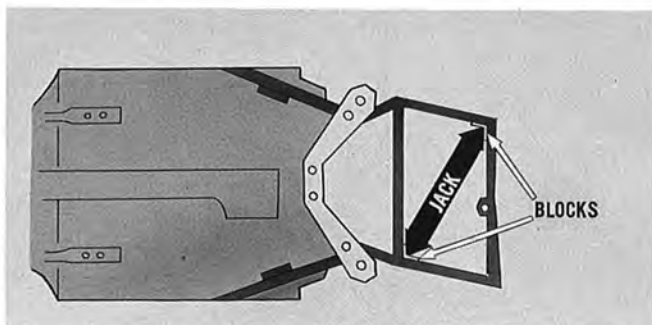

If the engine has been removed, a MINOR SIDESWAY of the engine compartment can be straightened by the use of a jack and proper protective blocking. The jack should be placed diagonally across the engine opening.

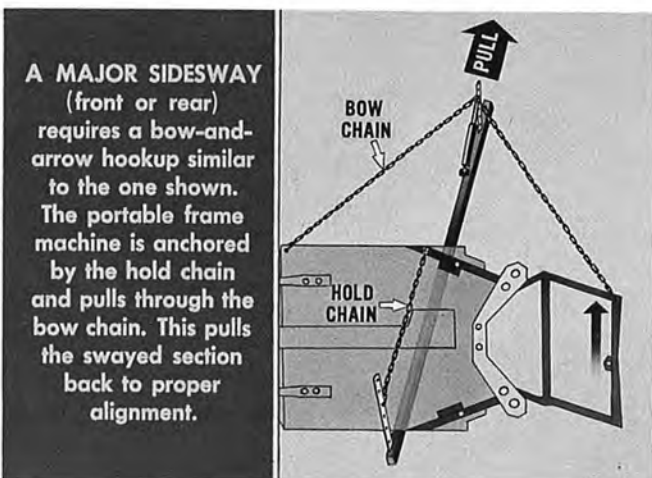

A MAJOR SIDESWAY (front or rear) requires a bow-and-arrow hookup similar to the one shown. The portable frame machine is anchored by the hold chain and pulls through the bow chain. This pulls the swayed section back to proper alignment.



**GENERAL NOTE** Experienced body and frame repairmen will recognize the importance of not using excessive force with any type of frame machine.

To help reduce the amount of pulling force required when straightening damaged "work-hardened" areas, hand tools and the application of heat should be used as necessary.

Depending on force alone can cause additional metal damage and broken equipment.

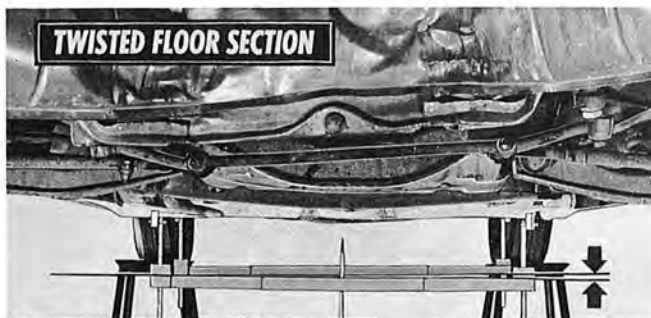

The condition of twist is confined to the floor pan section area of the body. Twist can be determined by sighting for misalignment of the horizontal bars of the two center-line gauges as shown. Twist is the result of a raised or sagged condition affecting the entire lower structure.

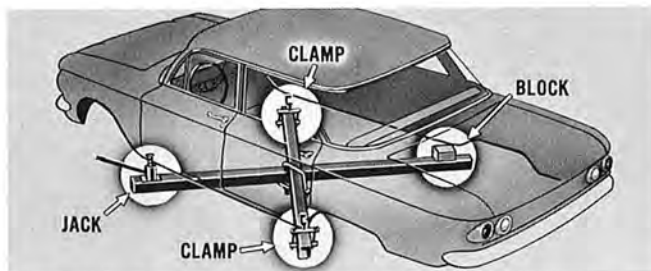

To bring the twisted section back to alignment requires the following combinations of holding and lifting: Anchor clamps are attached to opposite corners of the rocker panel lower flanges and to an "X" beam (accessory unit) bolted to the frame machine. A block is used on one end of the main beam and a jack on the other.

A check for misalignment of the lower structure should be made through a combination of visual inspection and gauging. When examining the body and structural members always:

- Suspect misalignment beyond the point of visible damage, particularly if door or window openings are misaligned and where experience indicates it probably will occur.
- Check carefully for combined damages which may require various combinations of the basic hookups previously shown.



When using a tram, two persons should support the bar, to prevent sag or pointer deflection. The measurement specifications needed to set tram bar pointers horizontally and vertically are given in the Corvair Shop Manual.

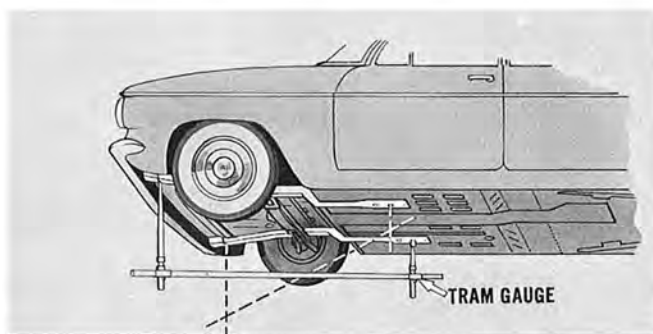

The tram gauge is also used to check structural sideway by setting the pointers to reference points on one diagonal and transferring the tram to corresponding reference points on the opposite diagonal.



**THREE-POINT CHECK**

Another use of the tram is to compare a suspected sag or raise on one side with the opposite side (if undamaged) or with another undamaged automobile. Three pointers attached to the tram bar are required. Reference points must be in a straight line.



**USES OF CENTERLINE GAUGES**

Sagged, swayed or raised members can also be checked through the use of three centerline gauges. By sighting along the centerline pins and the level of the cross bars, the extent and location of damage to the lower body structure can be easily determined.

In PART I, the fundamentals of alignment checking, the result and nature of impact on structural members, and how to relate these damage conditions to suitable repair methods have been discussed.

PART II, which follows, concerns the application of these principles to the repair of a Corvair with major front end collision damage.

**PART II** also includes panel straightening where it is affected by the realignment of structural members.

## Part II

### PRACTICAL REPAIR METHODS

The following repair coverage explains and illustrates the exact procedures used to restore structural alignment and shape of a Corvair with major front end damage.

These basic ideas can be directly and effectively applied to other damaged automobiles regardless of the extent and location of the damage.

Before actual repair operations are started two essential steps should be performed. They are:

#### **ANALYZING DAMAGE CONDITIONS**

Inspect all visible bends, collapses and torn metal in the structural members and panels. This preliminary examination will help to indicate the area of possible minor misalignments. Gauging will accurately determine if such damage is present.

#### **PLANNING REPAIR PROCEDURES**

Plan what to do to determine the order in which structural members and panels should be straightened and plan how to effectively use the jack and frame machine setups.

This approach should always be followed on all major collision jobs.



**ANALYZING DAMAGE CONDITIONS**

The impact which caused this major damage struck from an angle of about 25 degrees. On the exterior, the deeply dented front panel has twisted and drawn the front fenders inward. On the interior, the condition of —

—the crumpled front compartment pan indicates probable damaged side rail members and misalignments that may have penetrated into the lower structural members beyond the point of visible bends.

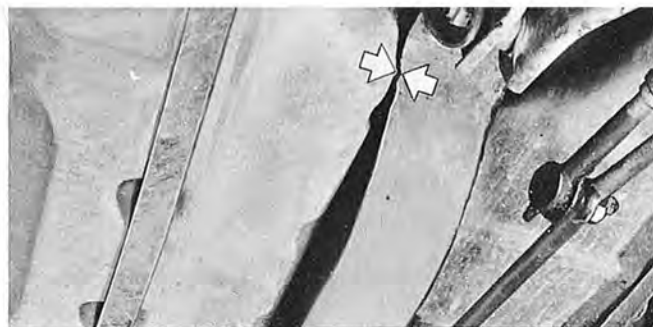

The cross member was too close to the gasoline tank, indicating that the complete front suspension unit may have shifted rearward. However, no side rail buckles were visible to the rear of the suspension cross member.

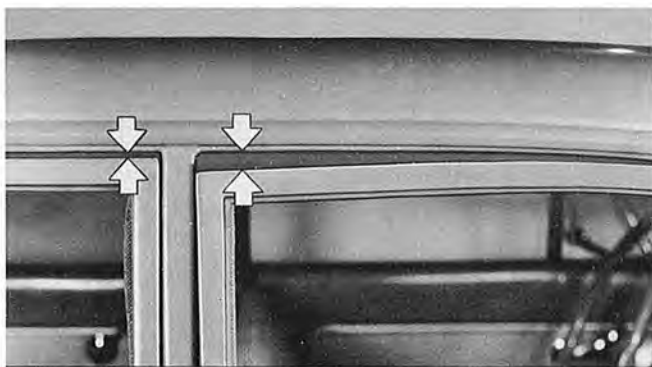

Another important indication of structural misalignment is also found in the "out-of-line" condition of the right front door opening.

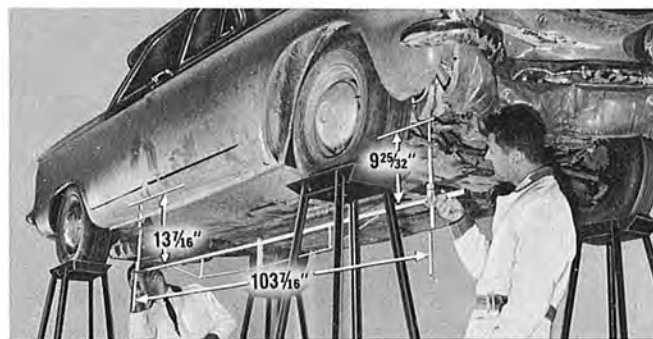

This suspected rearward shift was proved with a tram gauge set to Shop Manual specifications for both length, and height above datum line. The right side was short  $\frac{3}{4}$ " — the left side,  $\frac{1}{4}$ ".

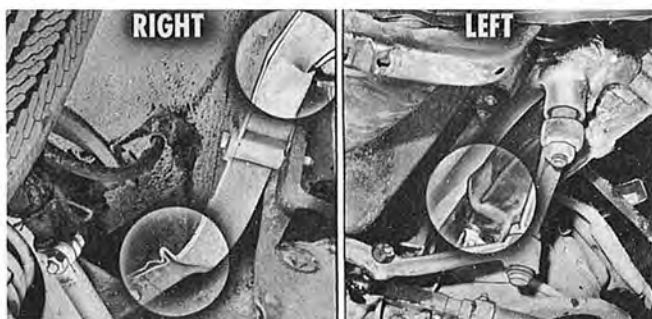

On the underside, both side rails have major structural damage ahead of the front suspension cross member. The right side rail has both a bend and a collapsed section. The left side rail has a single sharp bend on the inside.

## PLANNING REPAIR PROCEDURES

Having determined the conditions of structural misalignment, the next step was to visualize and plan the sequence of straightening each member and panel. A layout of the structural members showing the misalignment follows:



To align the front sections of the side rails, the left side must be pulled outward. The right side must be pulled both forward and outward. These operations should also be planned to include alignment of the front suspension assembly.

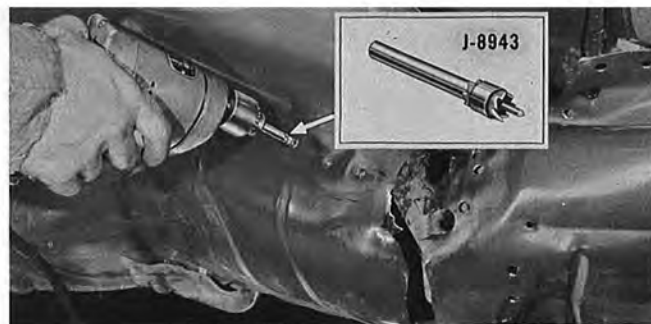
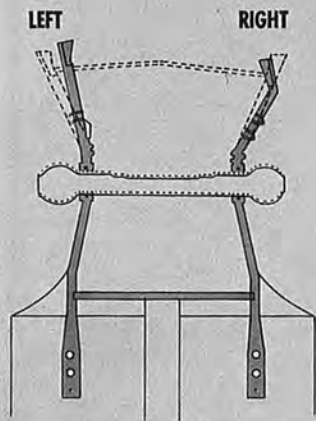

A spot-weld cutter, such as J-8943, was used in all panel removal. Where welds were difficult to locate, paint was burned with a torch and the surface wire-brushed clean. A punch mark helped center the cutter on the weld.

The front panel, front section of the compartment pan, front body cross member and the pan reinforcements will be replaced because of major damage. Removing these parts will release the inward strains on both side rails.

Straightening the rear section of the compartment pan will require less time than an installation of a complete pan assembly. Also, the stiffening effect of keeping this pan section attached will help to maintain alignment of the complete front end sheet metal during the straightening operations.

The front panel and body cross member were removed first. The front of the compartment pan was left in place temporarily to hold shape of the rear section during rough-out operations.

Partial straightening of this scrap pan section will be required to release strains on the side rails. The advantage of holding shape in this manner will simplify the repair procedures and reduce the over-all time.



Before straightening operations were started, the front suspension system and gasoline tank assembly were removed. Two bolts were then reinstalled in the brackets as shown to prevent the support bar from slipping out of position.



The portable frame machine was set up and used to partially straighten the front section of the compartment pan. The machine was anchored at the rear by—



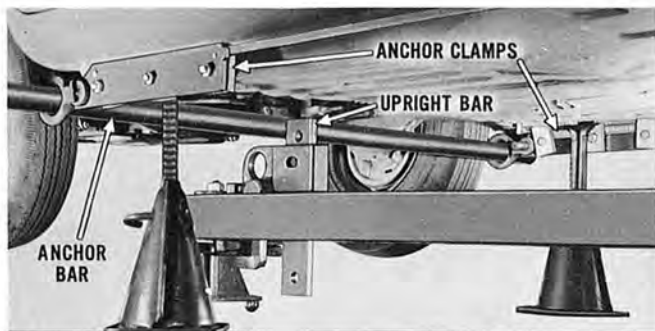

—anchor clamps which attach to the rocker panel flanges to support the anchor bar. This provided a solid anchor point for the upright bar at the rear end of the frame machine.

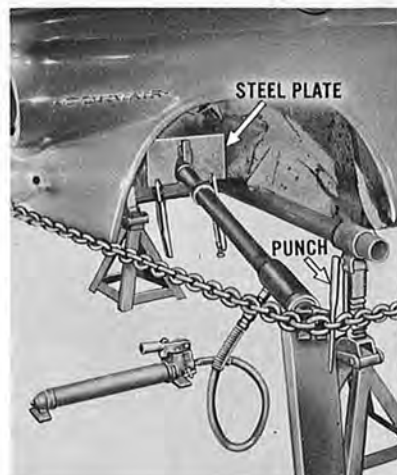

To prevent crushing the side rail, one end of the jack bears against a steel plate. The opposite end is supported in a level position and bears against the chain sling. The punch prevents the jack from slipping on the chain.



The front end of the frame machine was attached by tack-brazing a metal strip to the underside of the front compartment pan. This was then pulled forward just enough to relieve the inward strains on the side members.

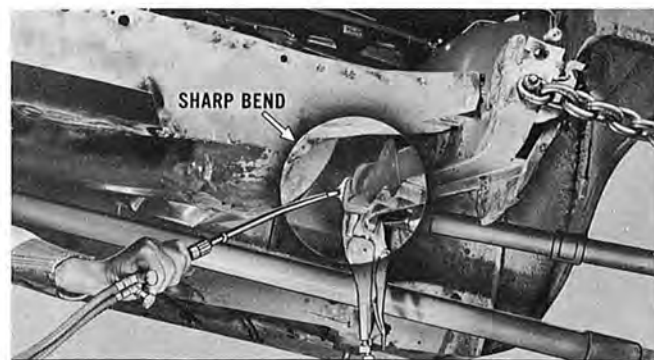

Heat was then applied to the sharp bend as the jack was extended, pulling the side rail outward to proper position.



A jack and chain sling was set up to pull the front end of the left side rail outward. The rear end of the chain sling was hooked around the anchor clamp. The front end was bolted to the end of the side rail.



To check the result of the chain sling setup, two diagonal tram measurements were made from different reference points. The tram was first set to reference points shown and then checked on an undamaged automobile. A second check was made by using the "B" specifications listed in the Shop Manual.



The bumper support bracket on the right side rail was then straightened by connecting the frame machine to a chain and heavy clamp as shown. Heat was applied to the sharp buckle to aid straightening.

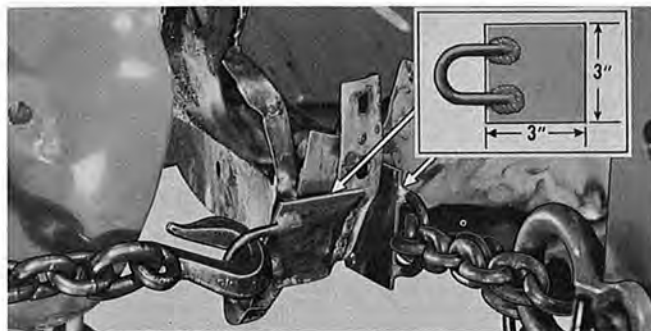

The front end of the frame machine was attached to the bumper support bracket through the use of special plates. These were locally made and then brazed in position as shown.

As shown previously, the right side rail had both an inward bend, and a collapsed section. By straightening the bend, the strain on the compartment pan will be relieved to permit roughing out of the rear section.

The repair of the collapsed section of the side rail followed completion of these operations.

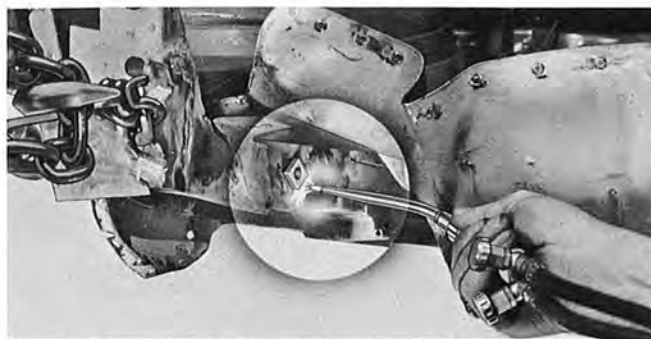

Heat was applied to the bend area as the frame machine pulled diagonally. This caused the end of the side rail to swing outward into proper shape and relieved the strain on the compartment pan.



The frame machine was set up diagonally to straighten the inward bend. The correct angle of the side rail was held during this operation by a chain sling.



To rough out the compartment pan, metal tabs were soldered to the outer surface and connected with a bar. This permitted pulling both sides at the same time. The chain was shifted as necessary. Hammers and a dolly block were also used.



A closeup of the soldered attachment to the compartment pan is shown. The proper technique of making this soldered attachment is not explained here because it is widely used and the information is available from many sources.

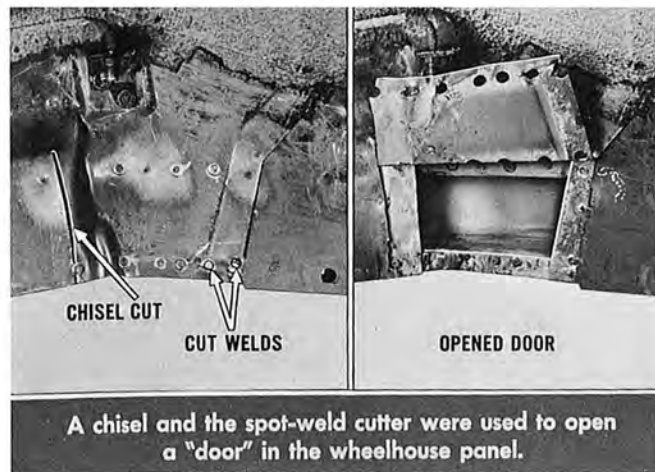

A chisel and the spot-weld cutter were used to open a "door" in the wheelhouse panel.



After general shape of the compartment pan had been restored, the damaged front section was cut away with a torch. A clamp and chain, connected to the frame machine, localized pulling force where needed, to assist the final hand tool operations.



Checking with centerline gauges showed the end of the left side rail slightly high. With the body tied down to the beam at the front and rear, extending the jack pulled the side rail to datum line specifications.

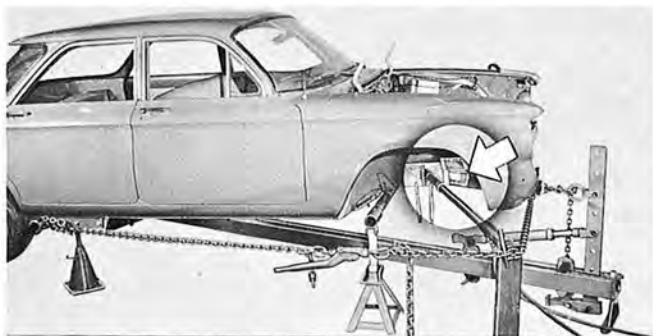

To pull out the collapse in the right side rail, the frame machine and chain sling were set up. The collapsed section was opened to permit access of heat and tools to reduce its resistance to the pulling effort.

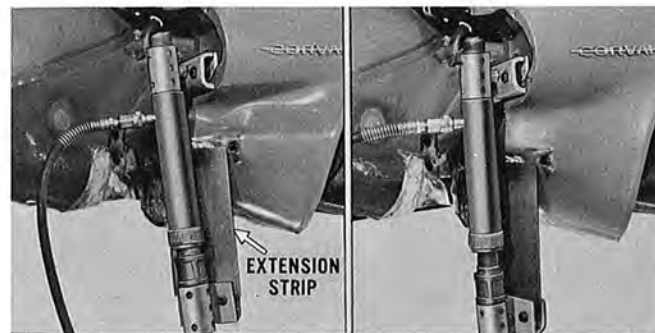

To pull out the crease in the left front fender, a jack, two clamps and a soldered-on extension strip were used. The strip was required to accommodate the length of the hydraulic jack.



After the structural members and the lower section of the left front fender were straightened, a new front compartment lid was installed.

The right front fender was only slightly out of alignment. However, the upper end of the left front fender was twisted inward about  $\frac{3}{4}$ " , preventing the lid from closing.

With the left side fitted, the frame machine was set up to pull the right hinge pillar forward to realign the right front door. To do this required both a pull and tie-down effect.

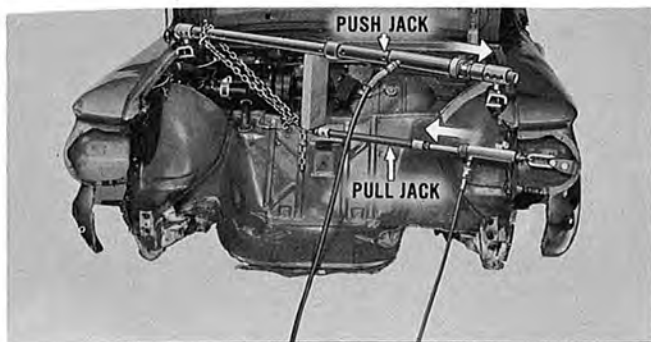

To correct the condition in the left front fender, an opposite twist was provided by pushing and pulling across the opening diagonally. The lower pull jack held back as the upper pushed to provide this effect.

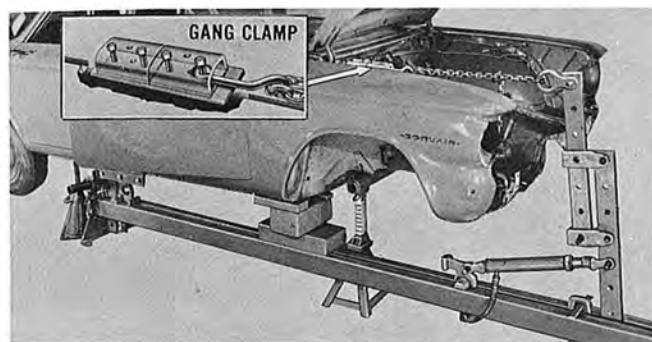

The machine was chained to the anchor bar at the rear end, blocks were used on the beam under the cowl pillar and the upright beam was connected to the weatherstrip flange by means of a chain and gang clamp.

Heat was applied to the left rear corner to relieve buckles caused by the original twist. This was necessary to avoid the use of excessive force.



Next, the frame machine was chained and clamped to the right side rail, and the jack and soldered-on tab were used to raise the end of the front fender. This setup maintained alignment of the side rail.

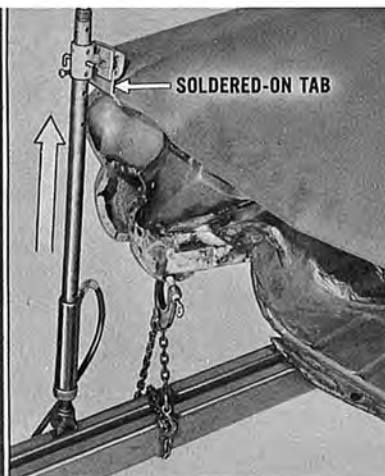





A pull under the headlight closed the gap between the front wheelhouse extension and front panel. This was found by setting the front panel in place temporarily as a final check of the over-all fit of the front fenders.



The front compartment pan was completely welded before installation of the new front panel to provide easier accessibility. The oxyacetylene torch was used for this operation. However, an arc-spot welder (if available) may be used.

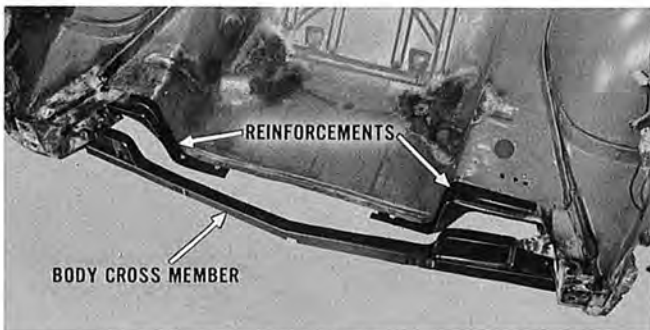

After establishing final over-all alignment, the hammer and dolly work was completed on the compartment pan. The new pan reinforcements and the body cross member were then fitted and tack-welded in place.

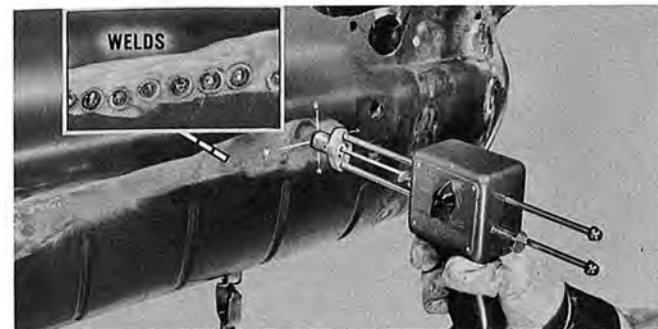

An arc-spot welder is shown welding the front panel to the front edge of the compartment pan. On some operations this is much faster than oxyacetylene welding, and produces a strong weld with practically no metal warpage.

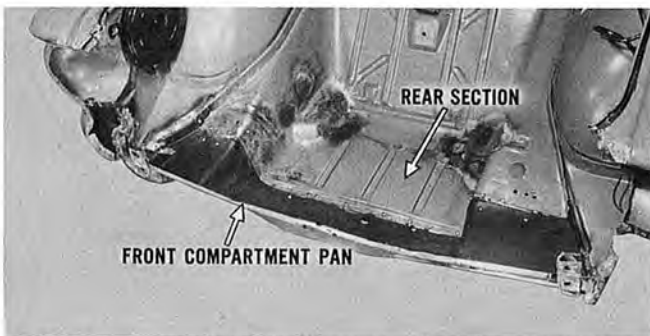

The front compartment pan was first aligned and tack-welded to the bumper support. Then metal screws were used to attach it to the rear section and compartment pan reinforcements to hold it for final welding.

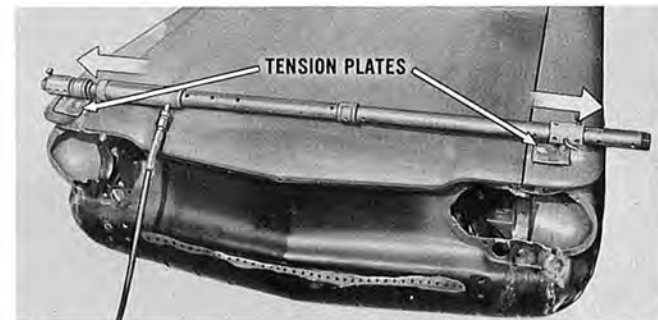

The final alignment of the lid and fenders was established with this setup. Soldered-on tension plates spread the fenders without crushing. Then, the upper corners of the front panel and front fenders were welded.

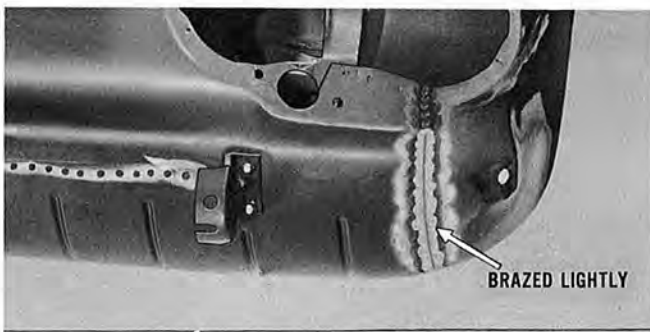

The lower flanges of the front fenders and front panel were clamped and welded on the inside. The outside of the joint was brazed over lightly to prevent possible "creep-out" of rust. A hacksaw cut restored the joint line.



After priming, body sealer was applied to both the inner and outer edges of the weld joints.

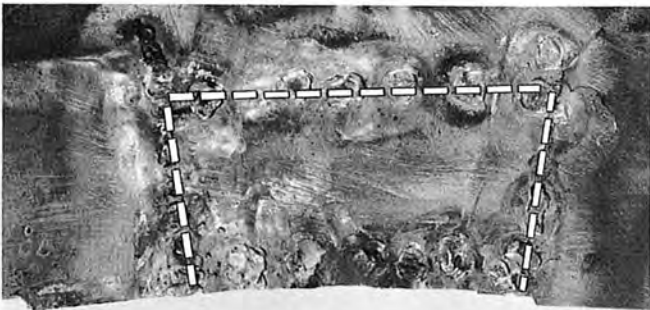

The doors in the left and right side rails (right side shown) were closed after all other welding was completed. This provided maximum strength to resist "weld draw" which might cause structural misalignment.



The finish job is shown, primed and ready for final painting. The bumper and headlight assemblies, emblem and lock cylinder have not been installed to insure that all surfaces will be painted. This provides protection against rusting.

Before priming, particularly in welded areas, all bare metal surfaces were wire-brushed clean to remove loose material. (If necessary, a cleaning solvent may be used.) The undersides of all panels which were burned by welding were given a ZINC BASE type of primer coat.

In PART II, the application of fundamental information and basic procedures has been shown on one damaged automobile. Other damaged automobiles will have different but similar problems to which these basic ideas will apply in principle, regardless of where the damage is found on the automobile.

These ideas will serve as valuable thought-starters when analyzing any severe damage and in planning repair procedures. Applying the methods shown in this film will make the repair of damaged Corvairs as easy as the repair of any other automobile.

**NOTES**

**NOTES**

PRINTED IN U.S.A.

AUGUST, 1960

CHEVROLET MOTOR DIVISION  
GENERAL MOTORS CORPORATION  
DETROIT 2, MICHIGAN