

CONTENTS

PART I

	PAGE
● DESCRIPTION AND OPERATION	1
● QUICK ON-THE-CAR CHECKS	8
Ventilating Air	9
Spark and Combustion Air	9
Fuel	11
● DETAILED ON-THE-CAR CHECKS	13
Ventilator Blower (High and Low Speed)	13
Combustion Blower	14
Secondary Ignition Circuit	15
Primary Ignition Circuit	16
Fuel Solenoid Circuit	17

PART II

● SERVICE PROCEDURES ON THE CAR	19
Primary Ignition Unit	19
Coil	22
Purge Switch	23
Heater Controls	23
Blower and Heater Control Switch	25
Thermostat	25
Pressure Regulator	26
Exhaust Tube	26
● SERVICE PROCEDURES ON THE BENCH	27
Burner Assembly	27
Ventilator Blower	40
Combustion Blower	41

SERVICING

PART
I

the

CORVAIR HEATER

COPYRIGHT 1959 CHEVROLET MOTOR DIVISION GENERAL MOTORS CORPORATION

THE CORVAIR HEATER

PART I

- DESCRIPTION AND OPERATION
- QUICK ON-THE-CAR CHECKS
- DETAILED ON-THE-CAR CHECKS

SEE PART II FOR:

- SERVICE PROCEDURES ON THE CAR
- SERVICE PROCEDURES ON THE BENCH

Your review booklet contains a complete reprint of Part I and Part II of this film.

DESCRIPTION AND OPERATION

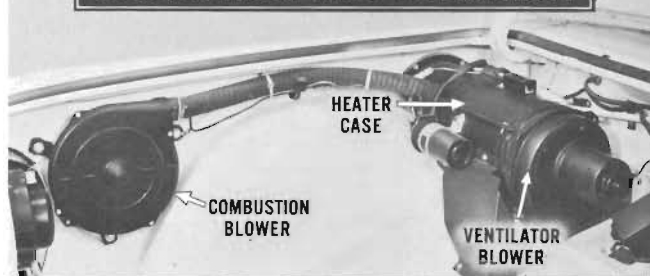

The Corvaire gasoline heater generates heat by burning a pressurized mixture of gasoline and air. Here we see the location of the combustion blower, heater case, and ventilator blower. The heater operates as follows:



FUEL: Gasoline, under pressure, is supplied to the heater through a line connected to the engine fuel pump. A pressure regulator (mounted on the car underbody) maintains the fuel pressure to the burner between 4 and 5 psi. Excess fuel from the pressure regulator returns to the fuel tank through a by-pass line.

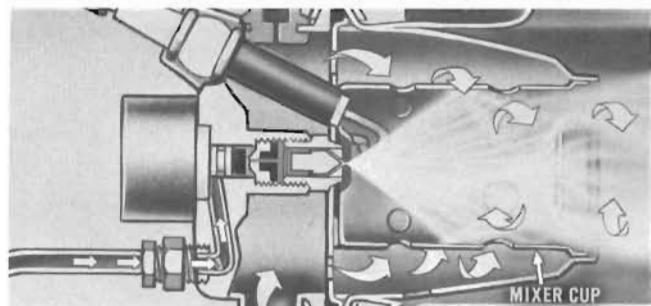

The nozzle breaks the fuel up into a finely atomized mist and sprays it into the mixer cup in a cone-shaped pattern. To insure thorough mixing of fuel and air, the burner parts are so constructed that the fuel and air enter the burner with a swirling or "corkscrew" motion.



COMBUSTION AIR: Pressurized air is forced to the burner by a combustion blower. This single-speed blower draws air from the front compartment, pressurizes it, and forces the air into the burner.

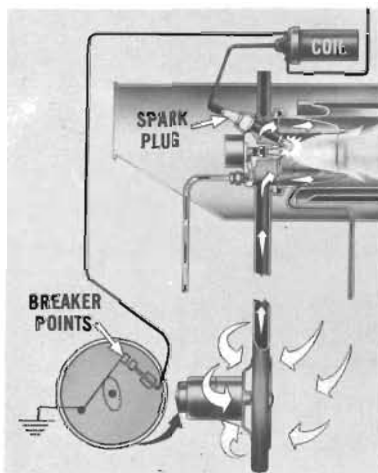

SPARK: The gasoline-air mixture is ignited by a spark plug installed in the end of the burner. The complete ignition system includes a coil mounted on the side of the heater case, and a set of breaker points mounted on the end of the combustion blower motor.

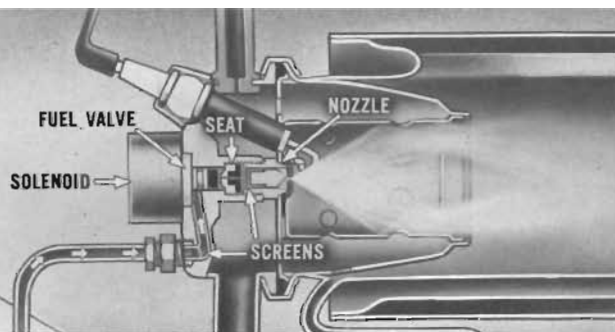

The fuel enters the burner through a screen, and a solenoid-controlled fuel valve which turns the fuel "On" and "Off." The fuel then passes through a second screen in the fuel nozzle and is sprayed into the burner.

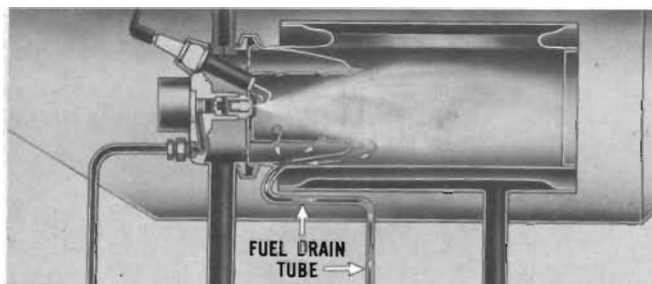

If for any reason the spark plug fails to ignite the fuel entering the burner, the unburned fuel drops to the bottom of the burner and drains away through a drain tube. A rubber hose connected to the tube conducts the fuel through the floor of the front compartment and discharges it to atmosphere.

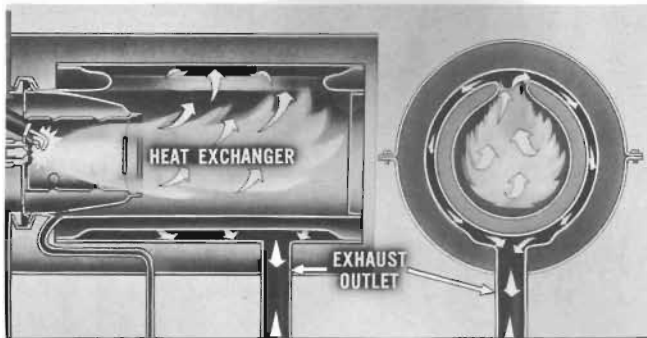

The fuel burns in the inner chamber of the stainless steel heat exchanger. The hot gases then flow up, around, and down through the outer chamber of the heat exchanger and out the exhaust outlet.

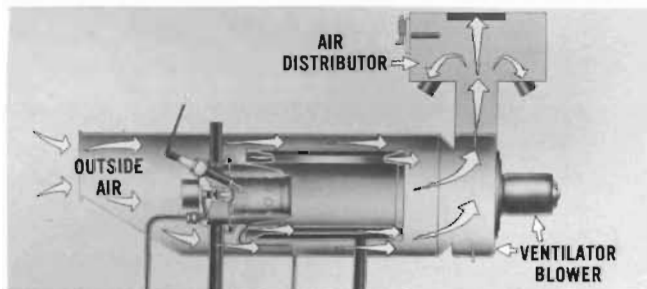

The heat is transferred to the passenger compartment by a ventilator blower. This blower draws outside air into the heater case from the cowl vent. The air travels through the heater case, picks up heat from the heat exchanger, and is then forced through an air distributor located inside the car.

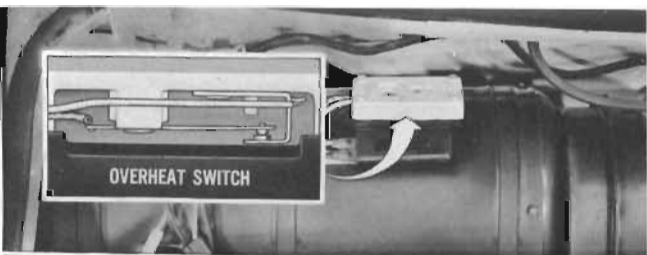

Overheat Switch: As a safety device, this switch opens the electrical circuit to the fuel solenoid, shutting off the flow of fuel to the burner should the temperature within the heater case become excessive. When the temperature within the heater case drops to safe limits, the switch will automatically reset itself. This switch is "factory set" and cannot be adjusted.

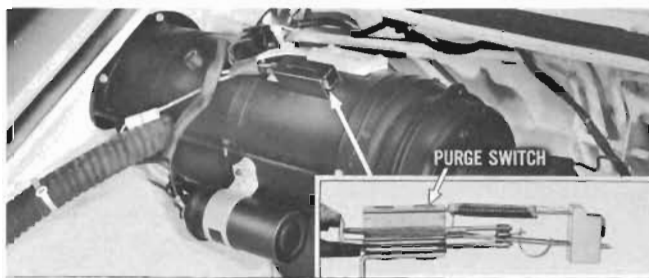

Purge Switch: A Purge Switch keeps the combustion blower operating for 30 seconds to 2 minutes after the blower or Ignition Switch is turned off. By continuing to run, the blower purges the burner of all combustion gases in preparation for the next heating cycle. The Purge Switch operates as follows:

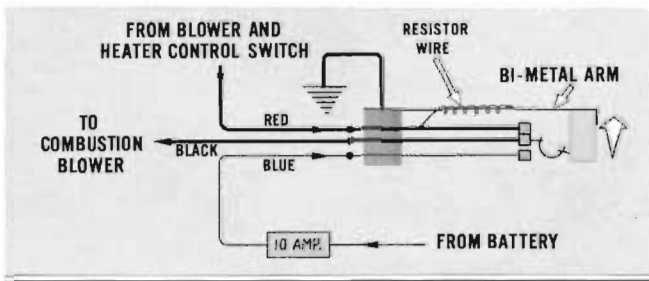

At the beginning of heater operation, current from the red wire flows through the upper to the middle Purge Switch contacts to the combustion blower black wire. An insulated resistor wire is connected to the grounded bi-metal arm, and the top contact. Part of the current flows through the resistor wire causing it to heat and warp the arm upwards.

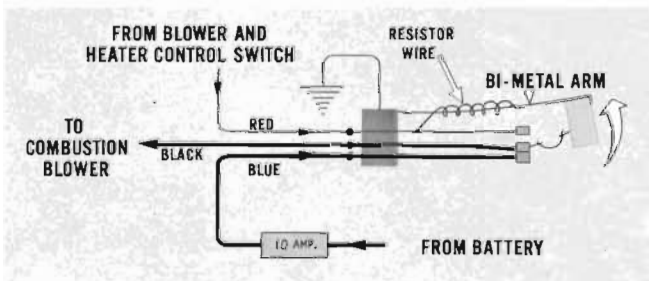

Within 30 seconds to 2 minutes, this warpage causes the middle contact to snap down against the bottom contact. Combustion blower current is then supplied through a separate 10 amp. fuse circuit (blue wire). However, current through the resistor to ground is maintained from the heater red wire.

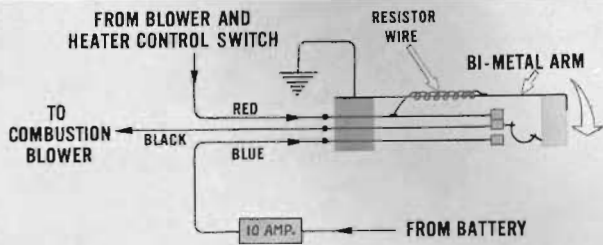

When the Ignition or Blower Switch is turned off, the combustion blower continues to run for 30 seconds to 2 minutes until the resistor cools enough to allow the arm to separate the middle and bottom contacts.

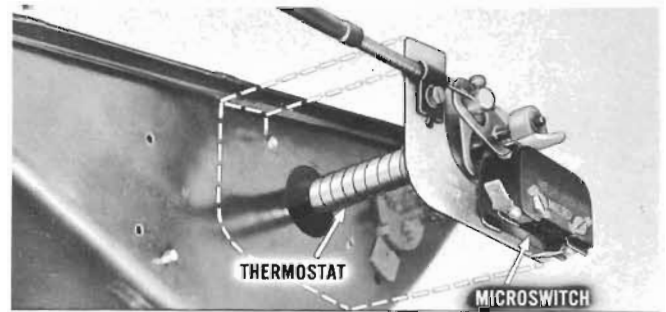

The HEAT control lever regulates a thermostat which projects through the side of the air distributor into the air stream. The thermostat is factory set so that a change of approximately 5 degrees in air distributor temperature is sufficient to actuate a microswitch.

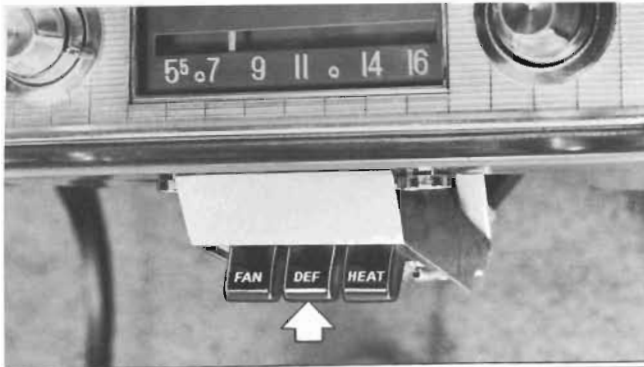

Heater Control Levers: Three heater control levers control all phases of heater operation. The DEF control lever serves the same purpose as in the conventional heater.

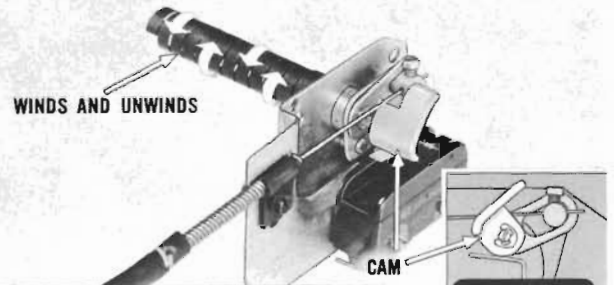

A coiled heat sensitive element of the thermostat tends to "wind" and "unwind" with changes in air temperature and actuates the microswitch through a cam which turns the burner ignition and fuel supply solenoid on and off.

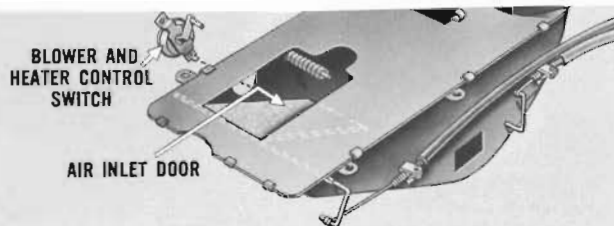

The FAN control lever operates an air inlet door and a Blower and Heater Control Switch. This switch serves four functions:

- Controls low speed of ventilator blower.
- Controls high speed of ventilator blower.
- Provides power to the single-speed combustion blower.
- Provides power to the electrical components of the heater.

It should be noted that the thermostat controls temperature by stopping and starting the burner flame rather than by controlling the intensity of the flame.

Therefore, it is normal for the sound of the heater to change slightly as the thermostat operates.

SPECIAL NOTE:

Because a gasoline heater is new and different to owners, many owner complaints are likely to be due to their unfamiliarity with normal heater operation. In instances where you suspect this to be true, first operate the heater in the normal manner. If it works, check out the owner to make certain he understands. The following instructions for operating the heater are for your convenience:

HOW TO OPERATE HEATER

FOR VENTILATING OR DEFOGGING:

Ignition Switch must be on.

- Advance FAN control to low or high speed position.
- Operate DEFrost control as in conventional car.

FOR HEATING OR DEFROSTING:

Engine must be running to supply fuel to heater.

- Advance FAN control to low or high speed position.
- Advance HEAT control lever to obtain desired heat. (Depending on placement of HEAT control lever, discharge air ranges between 65 to 145 degrees.)
- Operate DEFrost control as in conventional car.

QUICK ON-THE-CAR CHECKS

Diagnosing a service complaint is a simple process of elimination. If you have proper air, fuel and spark, you will have heat. The following quick on-the-car checks will help you pinpoint the area in which the difficulty is occurring:

- VENTILATING AIR
 - SPARK AND COMBUSTION AIR
 - FUEL
- Proceed as follows:**

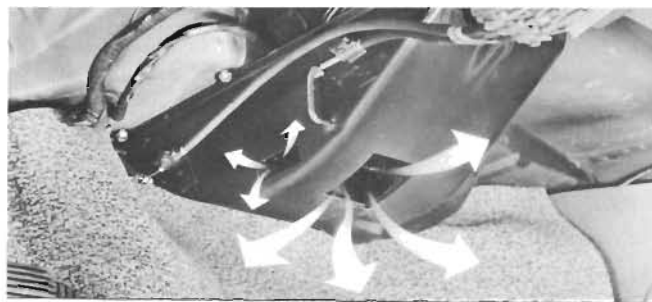

QUICK-CHECK — VENTILATING AIR:

- Fully advance FAN control lever.
- Turn on Ignition Switch.
- Feel for air being discharged at air distributor outlet.
- If there is no air flow, proceed as follows:

FOR VENTILATING OR DEFOGGING:

Ignition Switch must be on.

- Advance FAN control to low or high speed position.
- Operate DEFrost control as in conventional car.

FOR HEATING OR DEFROSTING:

Engine must be running to supply fuel to heater.

- Advance FAN control to low or high speed position.
- Advance HEAT control lever to obtain desired heat. (Depending on placement of HEAT control lever, discharge air ranges between 65 to 145 degrees.)
- Operate DEFrost control as in conventional car.

Check the 20 amp. heater fuse located in a fuse block to the left of the driver's compartment.

If fuse is okay, refer to VENTILATOR BLOWER — DETAILED ON-THE-CAR CHECKS.

20 AMP. FUSE

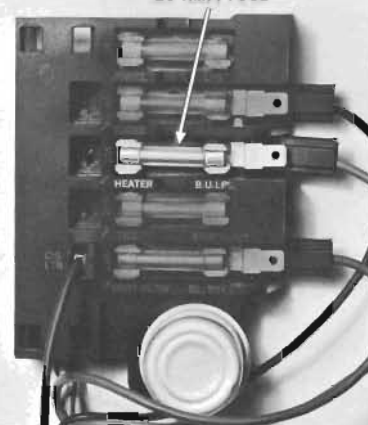

LISTEN FOR BLOWER OPERATING

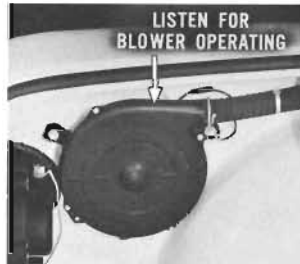

10 AMP. FUSE



QUICK-CHECK — SPARK AND COMBUSTION AIR: Turn on Ignition Switch. Fully advance FAN and HEAT control levers. Listen for blower operation and feel for discharge air at heater exhaust tube. If blower does not operate, check the 10 amp. fuse located in the fuse block. If fuse is good, refer to COMBUSTION BLOWER — DETAILED ON-THE-CAR CHECKS.



If combustion blower operates, disconnect ventilator blower and fuel solenoid connectors. Disconnect combustion blower hose and listen at open end of hose for typical arcing sound of spark between plug electrodes. If no spark noise is heard, the difficulty is in the heater ignition system. Refer to **SECONDARY IGNITION — DETAILED ON-THE-CAR CHECKS.**

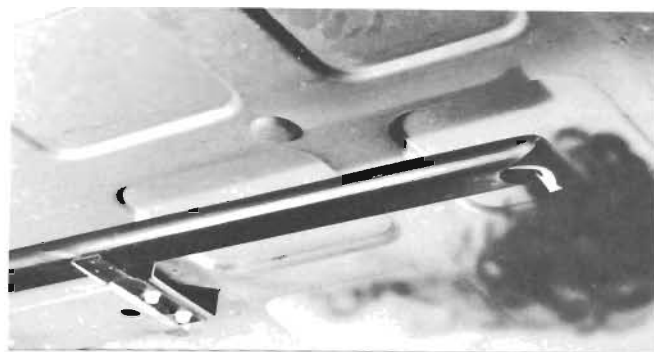

— if continuous black smoke appears, the difficulty is too rich a mixture due to excessive fuel pressure or insufficient combustion air volume. Check blower r.p.m. as follows:

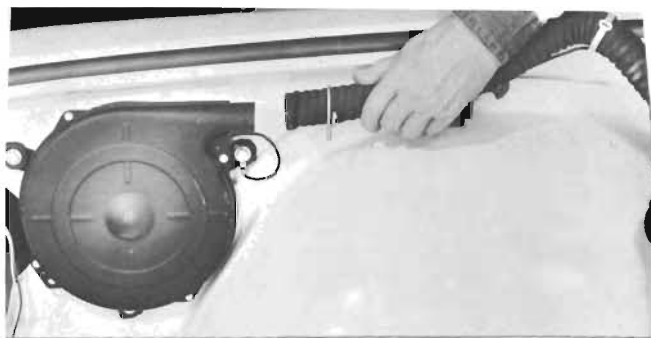

If spark noise can be heard, and air discharge from blower seems normal, reconnect hose, ventilator blower and fuel solenoid connectors. Start engine and look at heater exhaust outlet.



Connect a tachometer from brown wire terminal (—) on the ignition coil, to ground. Set meter on 4-lobe position. With engine running at fast idle, tachometer should read at least 2500 r.p.m., to provide proper combustion air volume. If r.p.m. reading is low, refer to **COMBUSTION BLOWER — DETAILED ON-THE-CAR CHECKS.** If blower speed is correct (2500 r.p.m. or more), refer to **QUICK-CHECK — FUEL**, to determine cause of rich mixture. Proceed as follows:

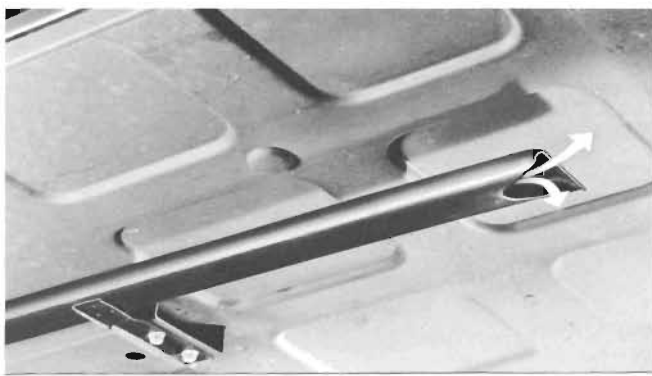

If no exhaust can be seen, there is probably no fuel to the burner. Check fuel supply system as shown in **QUICK-CHECK — FUEL.** However —



QUICK-CHECK — FUEL: With **FAN** and **HEAT** control levers fully advanced, and Ignition Switch on, separate white solenoid wire connector. Attach a test lamp between red-and-white wire and ground. If lamp does not light, refer to **FUEL SUPPLY — DETAILED ON-THE-CAR CHECKS.** If lamp lights, indicating that there is current to fuel solenoid, check fuel pressure as follows:

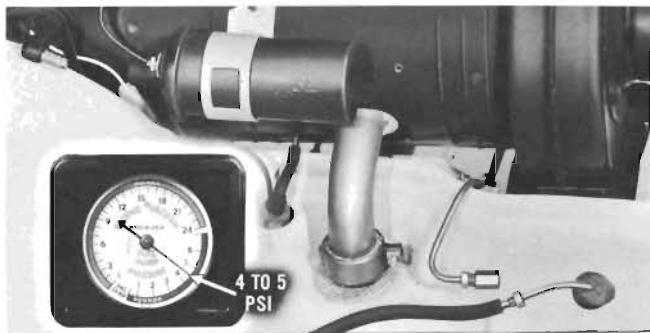

Fuel Pressure: Remove exhaust tube shield. Disconnect fuel line at union and attach pressure gauge to fuel supply line from pressure regulator. Run engine at idle speed. Gauge reading should be between 4 and 5 psi.

With correct fuel pressure and good Ventilating Air and Spark and Combustion Air, the cause of the heating complaint is in the

- Burner Fuel Section or
- Fuel Solenoid.

Refer to BURNER ASSEMBLY—SERVICE PROCEDURES ON THE BENCH.

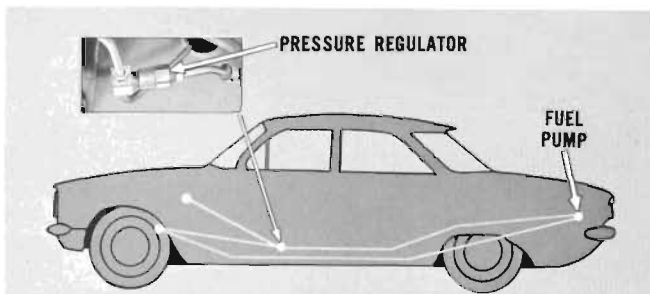

If gauge reading is less than 4 psi and fuel lines are clear, the fuel pump is probably at fault. Check fuel pump. If gauge reading is higher than 5 psi, regulator is at fault and should be replaced. If there is no gauge reading, fuel lines are plugged and should be cleaned with compressed air.

DETAILED ON-THE-CAR CHECKS

- VENTILATOR BLOWER
- COMBUSTION BLOWER
- SECONDARY IGNITION CIRCUIT
- PRIMARY IGNITION CIRCUIT
- FUEL SOLENOID CIRCUIT

Proceed as follows:

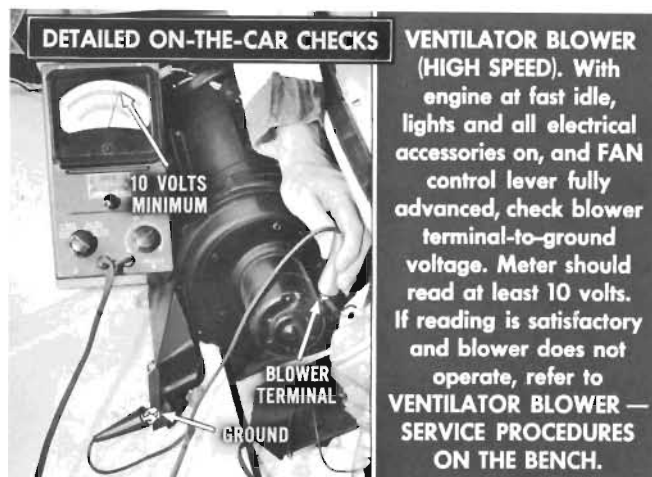

VENTILATOR BLOWER (HIGH SPEED). With engine at fast idle, lights and all electrical accessories on, and FAN control lever fully advanced, check blower terminal-to-ground voltage. Meter should read at least 10 volts. If reading is satisfactory and blower does not operate, refer to VENTILATOR BLOWER—SERVICE PROCEDURES ON THE BENCH.

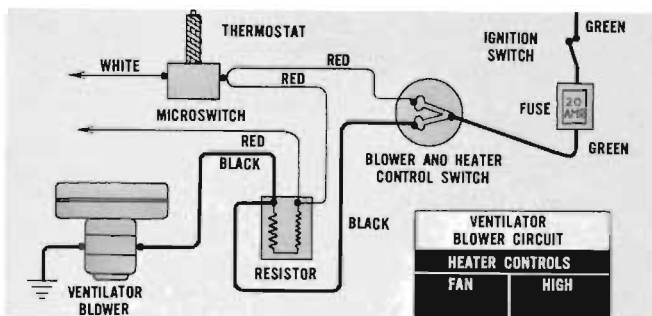

If reading is less than 10 volts the cause could be loose or corroded connections or weak battery. Follow the ventilator circuit back to the source of power to locate the cause of low voltage. NOTE: The resistor is located on top of air distributor.



VENTILATOR BLOWER (LOW SPEED).
 With engine at fast idle, lights and all accessories on, and FAN control lever in low speed position, check blower terminal-to-ground voltage. Meter should read 4 to 6 volts.

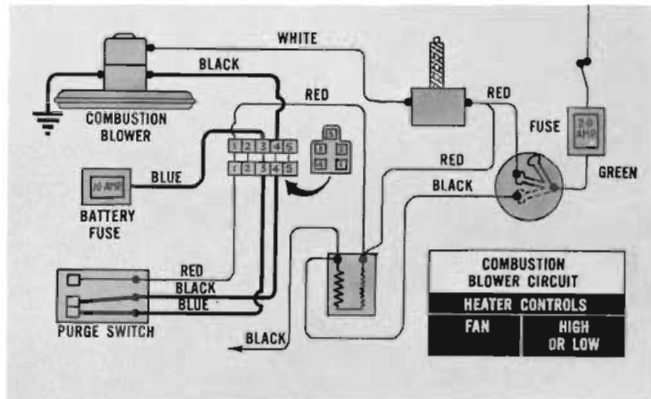

Follow the combustion blower circuit back to the source of power to locate the cause of low voltage.

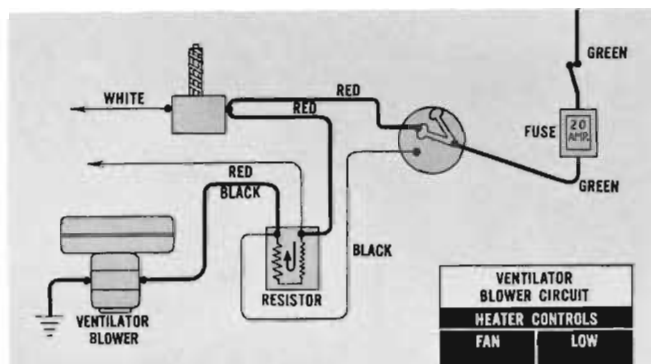

If reading is less than 4 volts, or more than 6 volts, follow the ventilator blower circuit back to the source of power to locate the cause of incorrect voltage.



SECONDARY IGNITION CIRCUIT. If no spark was heard during the quick-check, separate fuel solenoid wire connector to prevent fuel valve from opening.



COMBUSTION BLOWER — Fully advance FAN control lever. Run engine at fast idle. Turn on lights and all electrical accessories. Check voltage from black wire terminal on Purge Switch to ground. Meter should read at least 10 volts. Check connections in 5-way connector. If there still is insufficient air volume, refer to **COMBUSTION BLOWER — SERVICE PROCEDURES ON THE BENCH.** If voltage is low, proceed as follows:



Remove strap holding high tension wire to coil and remove wire. Insert another high tension wire in the coil tower and connect to an automotive spark plug gapped at .085". Ground the plug. Turn Ignition Switch on and fully advance FAN and HEAT control levers.



If arc across spark plug electrodes is strong and steady, the primary and secondary coil circuits are good. Service the heater spark plug as shown in **BURNER ASSEMBLY — SERVICE PROCEDURES ON THE BENCH**. If the arc is weak or intermittent, check the primary ignition circuit as follows:

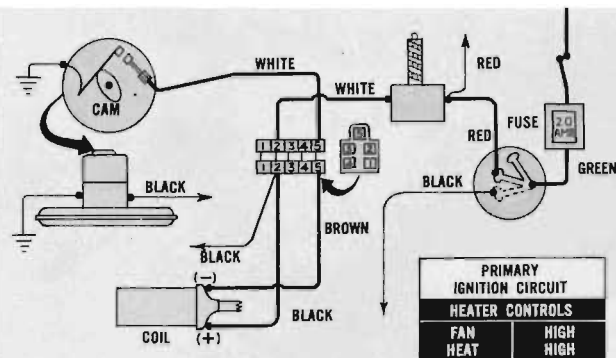

If the primary ignition point assembly is in good condition, trace the primary ignition circuit back to its source to locate the difficulty.



PRIMARY IGNITION CIRCUIT: Turn on Ignition Switch and fully advance FAN and HEAT control levers. Connect a voltmeter from brown coil wire terminal to ground. With combustion blower operating, voltage should read approximately 8 volts. If voltage is correct, primary ignition circuit is in good condition and the difficulty is probably in the coil. If voltage is considerably above or below 8 volts, proceed as follows:

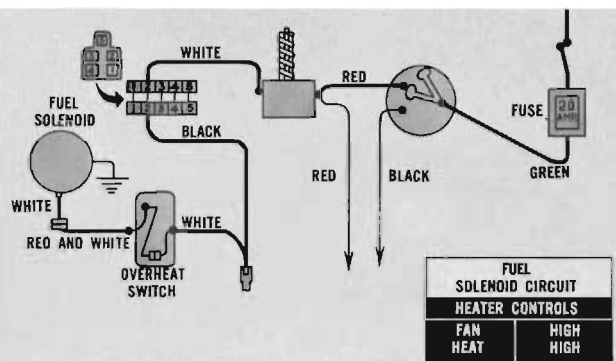

If in the quick-checks, there was no current to the fuel solenoid connector, check back through the electrical system for the open circuit and correct as necessary.

Remove combustion blower assembly without disconnecting wires, and place on fender cover. Remove ignition unit dust cover and inspect ignition points and breaker cam. Service as shown in **SERVICE PROCEDURES ON THE CAR**.

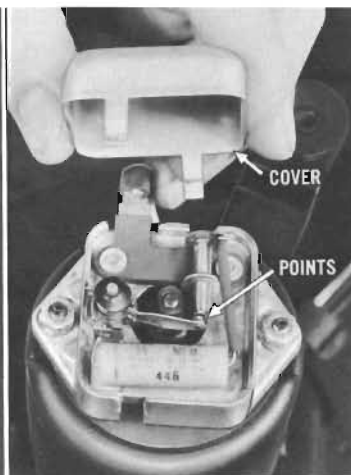

DIAGNOSIS SUMMARY

Now that we've seen how the heater works and the diagnosis procedures, here's how to handle a heater problem—

1. Check the owner's operation— is he operating it properly or is he expecting something abnormal.
2. Perform all the quick on-the-car checks to locate the area of difficulty.
3. Perform the necessary detailed on-the-car checks to pinpoint the problem.

To correct the problem, refer to Part II of Servicing the Corvair Heater.