

## END OF PART I

### Servicing the Corvair Heater

SEE PART II FOR:

SERVICE PROCEDURES ON THE CAR  
SERVICE PROCEDURES ON THE BENCH

## SERVICE PROCEDURES ON THE CAR

- Primary Ignition Unit
- Coil
- Purge Switch
- Heater Controls
- Blower and Heater Control Switch
- Thermostat
- Pressure Regulator
- Exhaust Tube

# SERVICING **PART II** the CORVAIR HEATER

COPYRIGHT 1959 CHEVROLET MOTOR DIVISION GENERAL MOTORS CORPORATION



**PRIMARY IGNITION UNIT:** The primary ignition unit can be serviced without removing the combustion blower entirely from the car. Disconnect the outlet air hose and remove the three bolts which secure the combustion blower assembly to the fender.

### Part I of Servicing the Corvair Heater covered

- Description and Operation
- Quick on-the-Car Checks
- Detailed on-the-Car Checks

### In this film we will see

- Service Procedures on the Car
- Service Procedures on the Bench

Remove cover from ignition unit mounted on the end of the combustion blower motor. Inspect points for excessive burning or pitting. Also check condenser solder connections. If points are in good condition, measure gap as follows:

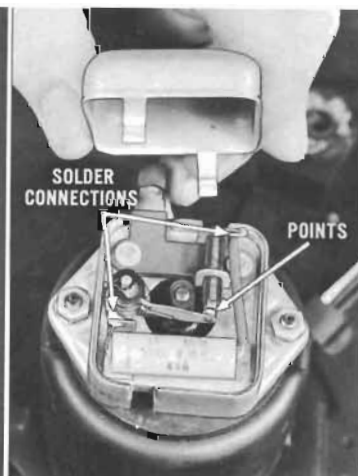

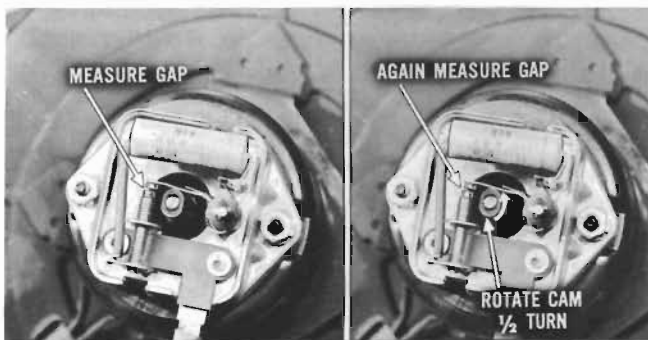

Check for .012" to .021" on each of the two cam lobes. A difference of more than .010" between lobes indicates one lobe of the fiber cam is excessively worn and cam should be replaced as shown later.

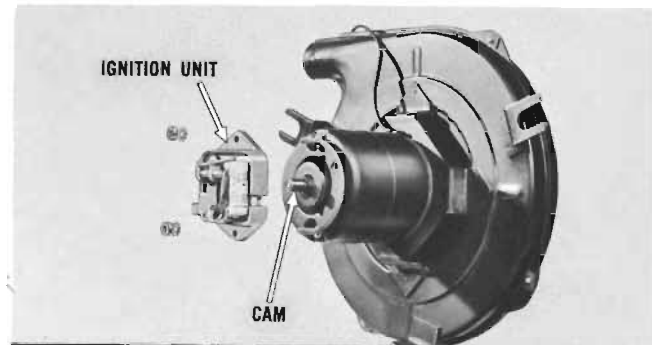

If points are damaged, if there is evidence of condenser failure, or cam is excessively worn — disconnect primary lead, remove two nuts and lockwashers, and remove ignition unit.



If point gap readings are within .010" of each other but either is below .012" or over .021", try to bring both gaps within desired reading by loosening the two ignition unit mounting nuts and shifting assembly slightly as permitted by bolt hole clearance.



To replace cam, hold other end of motor shaft with pliers and unscrew cam counterclockwise from threaded end of shaft. Install new cam by reversing removal procedure.

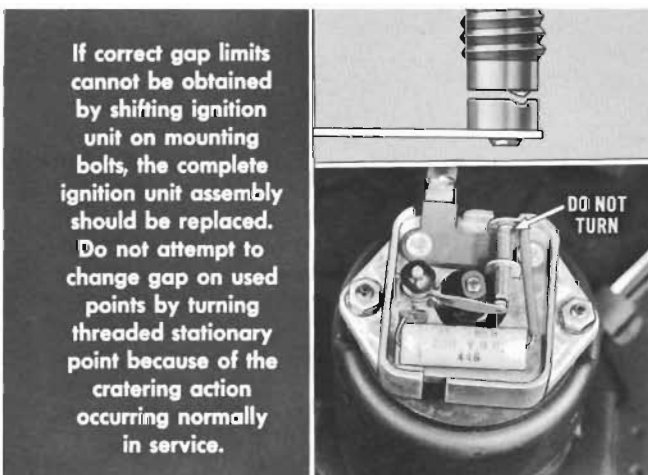

If correct gap limits cannot be obtained by shifting ignition unit on mounting bolts, the complete ignition unit assembly should be replaced. Do not attempt to change gap on used points by turning threaded stationary point because of the cratering action occurring normally in service.

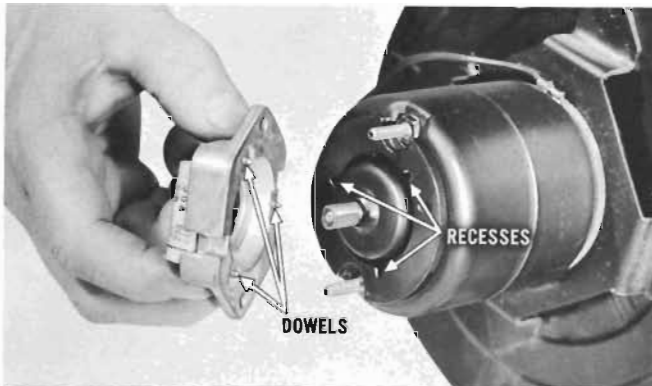

Install new ignition unit making sure the three locating dowels enter the recesses in motor end plate.

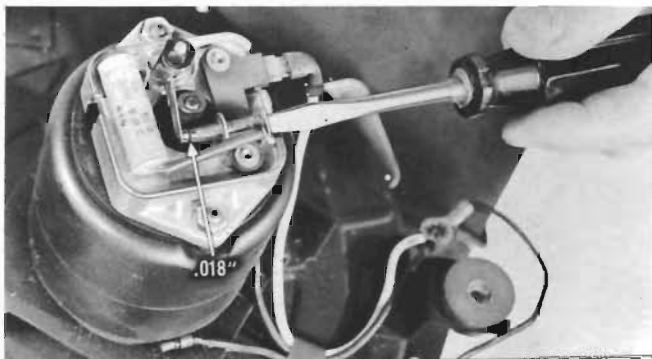

Adjust new points by turning threaded stationary point until gap on each lobe is approximately midway between .012" and .021". (Preferable gap is .018" on each lobe.)

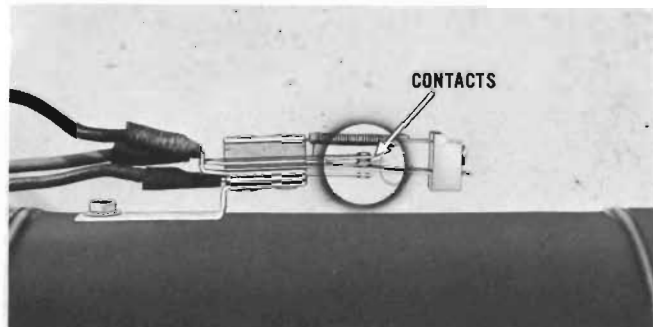

**PURGE SWITCH:** Dirty Purge Switch contacts may be cleaned with non-abrasive paper only. Do not attempt to recondition contacts by dressing with emery paper, sandpaper, or by filing.

Lock stationary point to prevent further adjustment in service by applying a drop of rosin core solder at each of the two locations shown. Install ignition cover. Mount blower assembly on car.

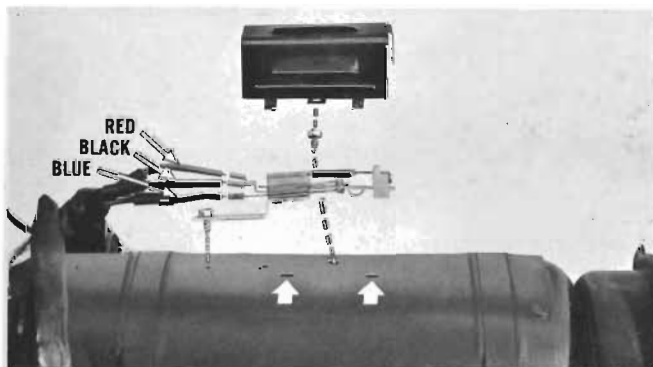

When replacing Purge Switch, be sure to solder wires to new switch as shown. Note that switch cover is secured by two spring tangs in front and one screw at rear.

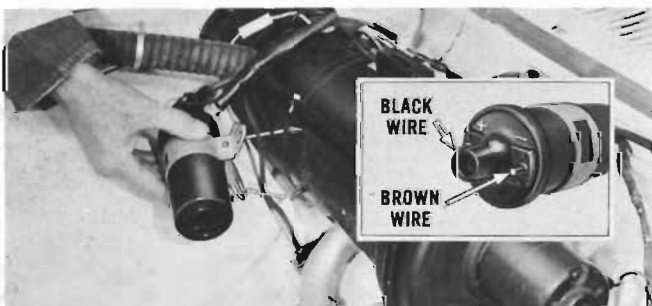

**COIL:** When replacing coil be sure brown wire is connected to the primary negative (-) terminal and the black wire connected to the primary positive (+) terminal. **NOTE:** This is a special high voltage coil. Do not attempt to replace it with a standard automotive coil.

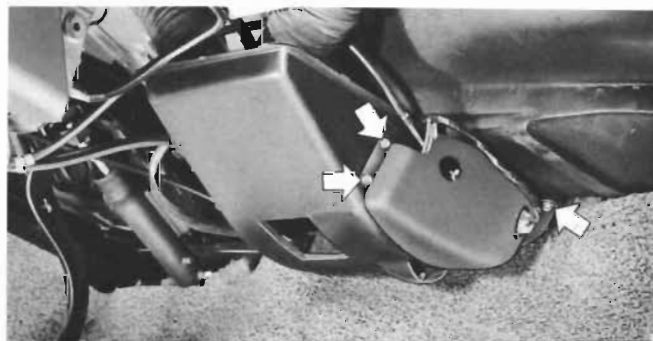

**HEATER CONTROLS:** The adjustment of the HEAT control cable is very important. To check adjustment, remove screws from cover on right side of air distributor. Remove cover.

With the HEAT control fully advanced, check to see that thermostat tension lever is in full clockwise position so heater can deliver maximum heat. Adjust as necessary by loosening trunnion screw and shifting trunnion on cable.

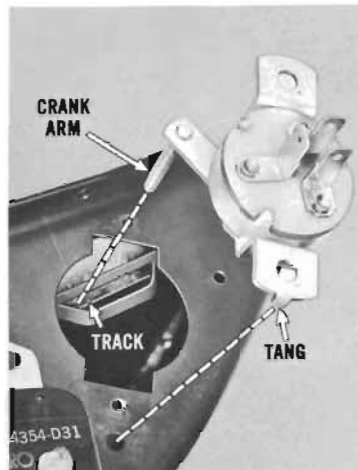

**BLOWER AND HEATER CONTROL SWITCH:**  
To replace switch, disconnect electrical leads, remove cover and remove switch from air distributor. Apply Lubriplate to crank arm on new switch. Be sure crank arm enters track on air inlet door, and tang on switch enters hole in air distributor.

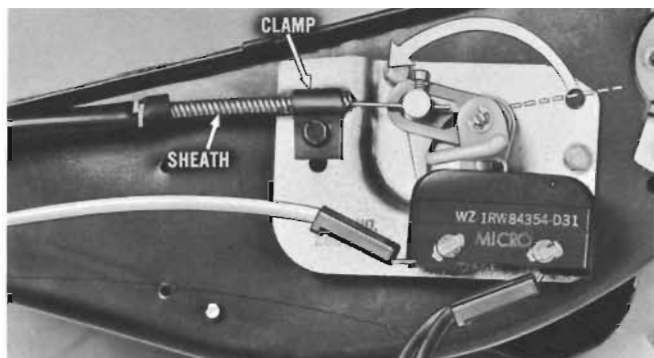

Move HEAT control lever to full "up" position. Make sure there is no interference with cable sheath when thermostat tension lever is in full counterclockwise position.



**THERMOSTAT:**  
Remove cover from side of air distributor. Separate the two electrical connectors from the microswitch of the thermostat assembly.

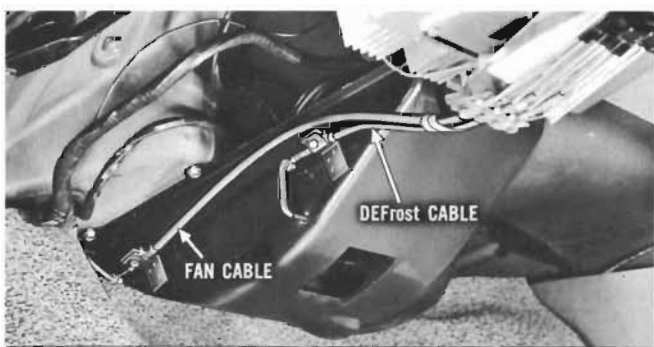

The DEFrost and FAN control cables have "eyed" ends at air distributor. The only adjustment possible to obtain full travel of either of these controls is by shifting the cable sheath in its retaining clamps.

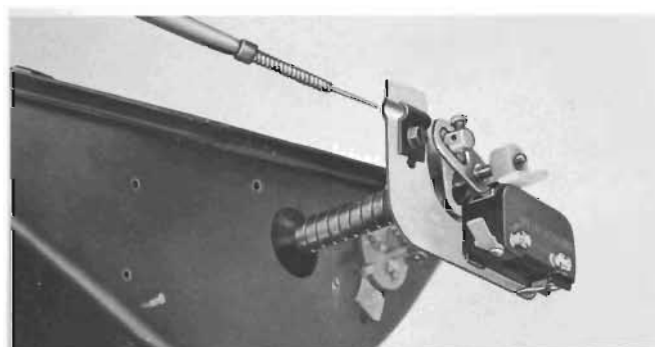

Disconnect HEAT control cable from thermostat and remove screws which secure thermostat to air distributor. Install new thermostat and adjust cable as shown previously.

The microswitch is preset at the factory and it is not serviced separately, nor is it adjustable in service. Any attempt to adjust the switch in service is almost certain to result in insufficient

heater output or a burned out heat exchanger. The factory adjusting screws are sealed with compound to prevent changing the adjustment.

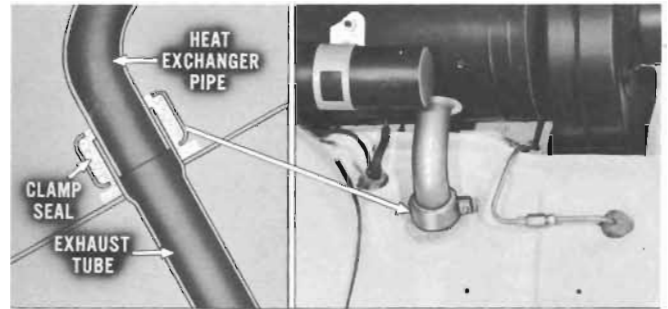
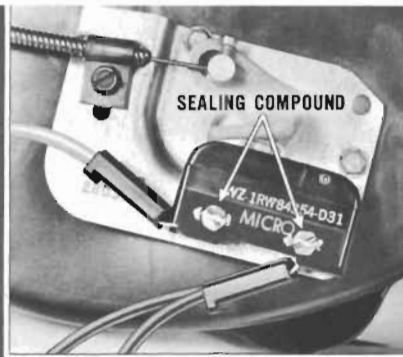

Install the heater exhaust tube, making sure it projects up into the luggage compartment. This locates the heat exchanger pipe correctly inside the exhaust tube, and the clamp and clamp gasket can now provide a good seal. Tighten the clamp securely. Install the metal shield.

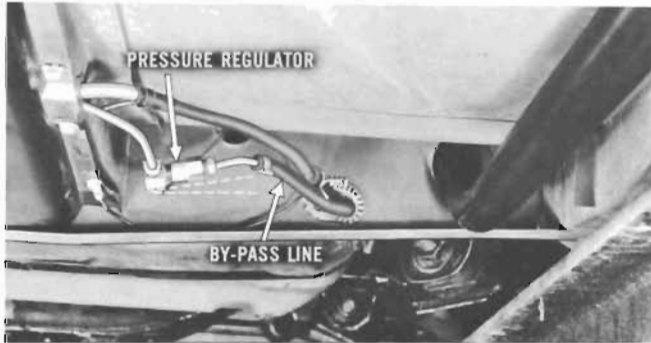

**PRESSURE REGULATOR:** When installing a new pressure regulator make certain the by-pass line is at or slightly above horizontal, so air bubbles or vapor will vent to the fuel tank.

## SERVICE PROCEDURES ON THE BENCH

- Burner Assembly
- Ventilator Blower
- Combustion Blower

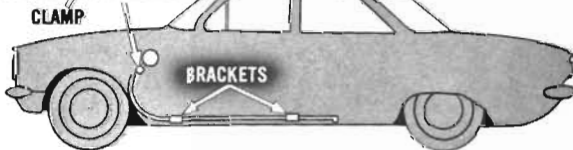

**EXHAUST TUBE:** To replace the exhaust tube, loosen the clamp which secures the exhaust tube to the heat exchanger outlet tube. Remove the bolts which secure the exhaust tube to mounting brackets on the car underbody.



**BURNER ASSEMBLY:** To get to the burner assembly, the top half of the heater case must be removed as follows:

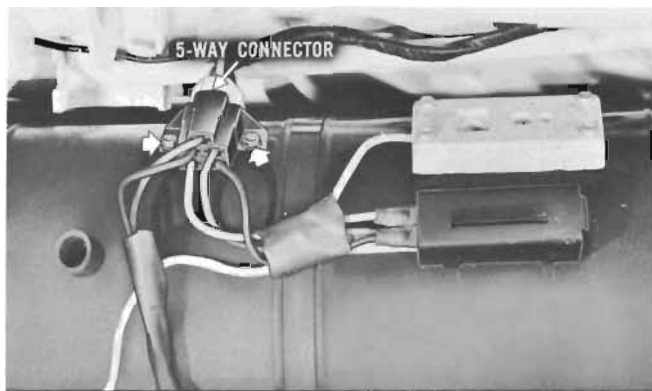

Loosen 5-way connector attaching screws. Slide connector loose from case. Separate connector.

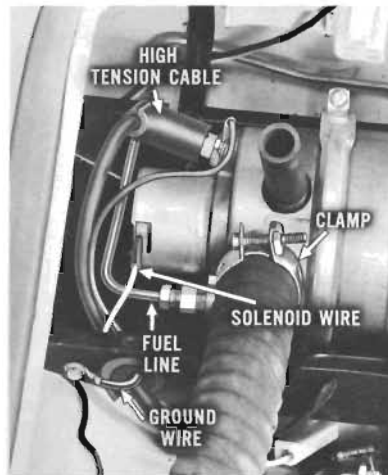

Remove the burner assembly from the car as follows: Disconnect the spark plug ground wire and fuel solenoid wire. Separate high tension cable from spark plug. Disconnect fuel line to burner. Loosen clamp securing combustion blower hose to casting.

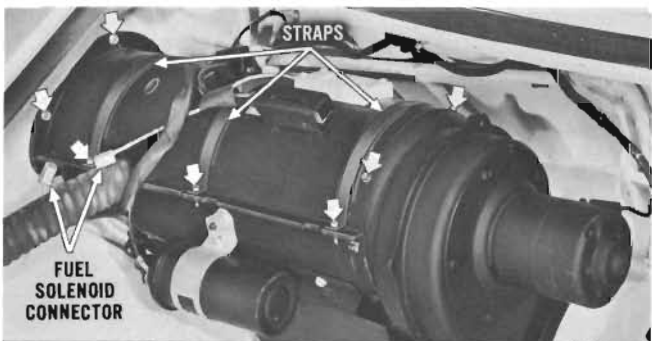

Remove two screws holding upper half of heater case to fender. Remove three strap screws. Remove two top screws holding ventilator blower housing to heater case. Separate fuel solenoid wire connector.

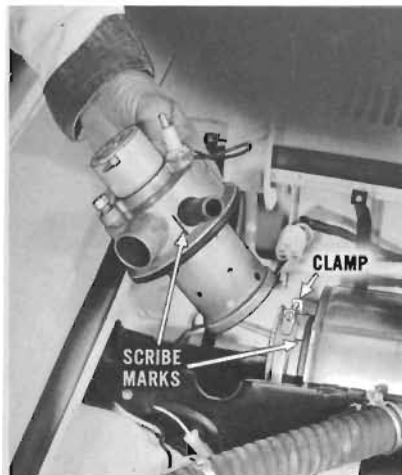

Scribe a line across burner and heat exchanger. Loosen burner clamp and pull burner out of heat exchanger and place on bench.

Bend all three straps as shown. This provides sufficient clearance for removal of upper half of heater case. Remove by lifting and rolling upper half of heater case forward and inboard, as necessary.



Before disassembling or removing any parts from a burner, note the condition or appearance of the mixer cup, which is very often a clue to the cause of unsatisfactory operation. In a properly operating burner, the end of the nozzle around the orifice will be gray — the inside of the mixer cup around the nozzle will be covered with a medium layer of carbon. The outer end will be burned to a gray or reddish color, and some scaling of the mixer cup will have taken place.

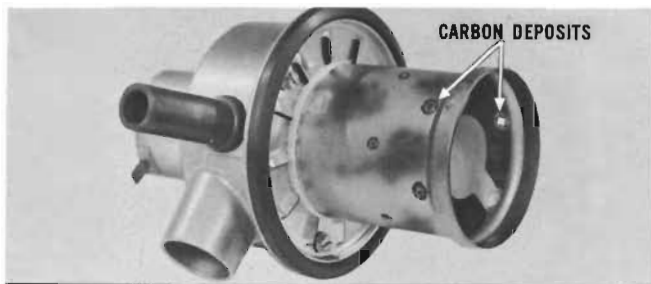

If the carbon build-up is uneven, carbon deposits clog or partially clog the air holes, or small areas of the mixer cup are excessively burned, the burner has been operating with an insufficient supply of combustion air, a one-sided fuel spray; or there has been fuel leakage inside burner casting.

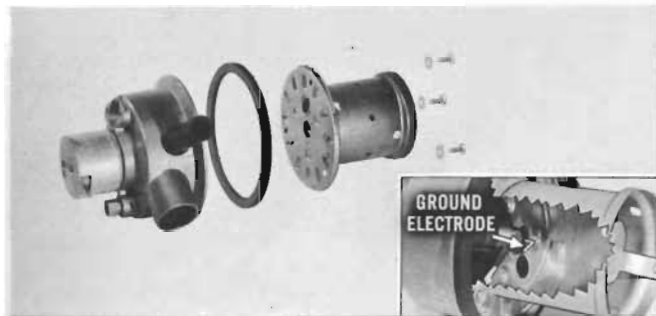

If mixer cup must be removed because of a badly burned shell, a burned-away ground electrode, or to test or service the fuel section of the burner housing, remove three screws which secure cup to housing. Separate mixer cup and gasket from housing.

Visually check for leakage around the fuel inlet connection and at the seal between the solenoid cup and burner casting. If there has been leakage, these areas will be dirt-caked or discolored.

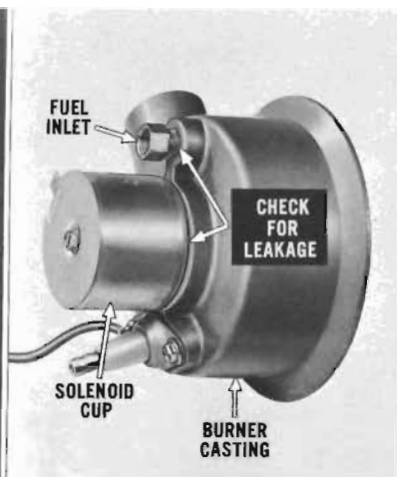

Excessive burning of the mixer cup shell or spark plug electrodes, insufficient heater capacity or erratic operation of the heater can be caused by an improper fuel spray pattern or continuous fuel leakage from nozzle. If any of these conditions are observed or suspected, or if the burner assembly has been removed to correct a specific fuel difficulty, the fuel section of the burner housing should be tested. Tool J-8367, which includes a test gauge and a special hose, is available for a complete test. If you do not have this gauge, a partial test may be made as follows:

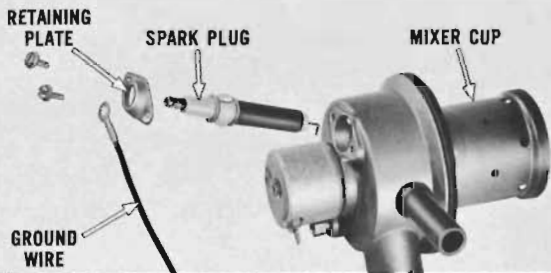

Remove two screws which secure the spark plug retaining plate and ground wire to the burner housing. Remove spark plug. Inspect spark plug electrode, and the ground electrode attached inside the mixer cup. If electrodes are badly burned, both the spark plug and the mixer cup must be replaced.

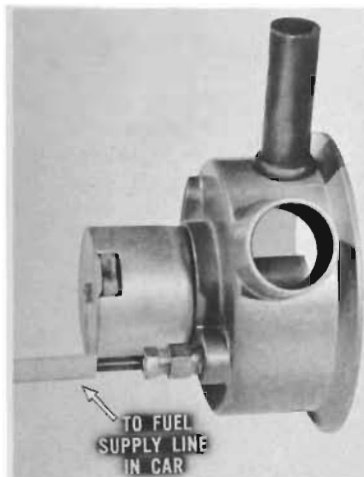

Connect a hose from the heater fuel supply line in the luggage compartment to a short piece of pipe installed in the burner housing fuel inlet fitting. The hose should be long enough so the burner housing can be located outside the luggage compartment.



Run a lead from the fuel solenoid terminal to some point where it can be connected to a convenient live terminal on the car. (Do not connect lead at this time.) Connect a ground lead between the car and the burner housing. The electrical lead should be connected and disconnected at the car because of the hazard of arcing at the burner assembly and possible ignition of gasoline.



Have someone disconnect live electrical lead at car. Fuel spray should stop. NOTE: A momentary dribble of fuel from nozzle is normal. There should not be a continuous dribble.

## CAUTION

These testing procedures simulate burner operating conditions. The tests must be made in a protected and well-ventilated location because **GASOLINE IS VERY INFLAMMABLE IN A SPRAY FORM**. Since there is always the possibility of arcing between terminals, do not make or break live electrical connections in the vicinity of the spray.

If Gauge J-8367 is available, make the electrical and fuel connections as shown previously. Set burner assembly squarely in gauge, with gauge resting on flat surface. (Do not use gasket between burner housing and gauge.) Reconnect electrical solenoid lead on car.



Have someone start engine and connect electrical lead from solenoid to a live terminal on the car (red wire at horn relay, or brown wire at windshield wiper connector). Fuel should spray uniformly from nozzle.

The top of the spray pattern should wet the walls of the gauge between the two limit lines as shown. Wetted areas need not be uniform; they may be irregular in shape but the top of the wetted area all must be within lines. If top of spray is outside limits, check fuel pressure. If pressure is correct, replace fuel nozzle.

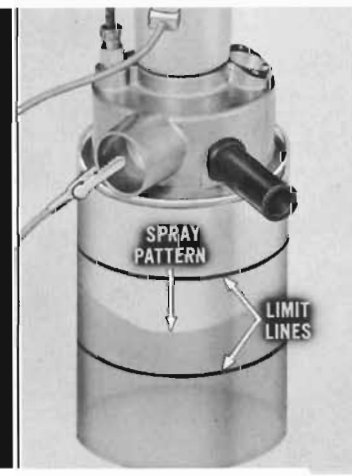



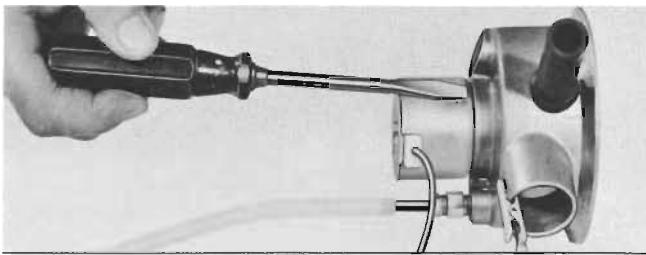

If no fuel sprays from nozzle, the solenoid coil, fuel inlet screen, fuel valve or nozzle assembly could be at fault. Check the solenoid coil by opening and closing the solenoid electrical circuit while holding the blade of a screw driver close to the solenoid cup. A good coil will attract the blade when the coil is energized. If solenoid coil is not functioning, stop engine and replace coil as follows:

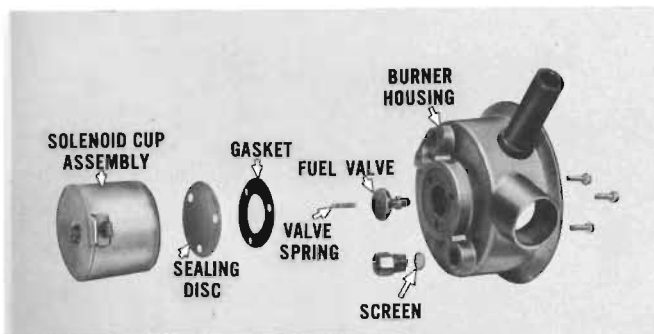

Remove fuel inlet fitting and screen. Remove three screws securing solenoid cup assembly to burner housing. Separate solenoid cup assembly, sealing disc, gasket, fuel valve spring and fuel valve from burner housing.

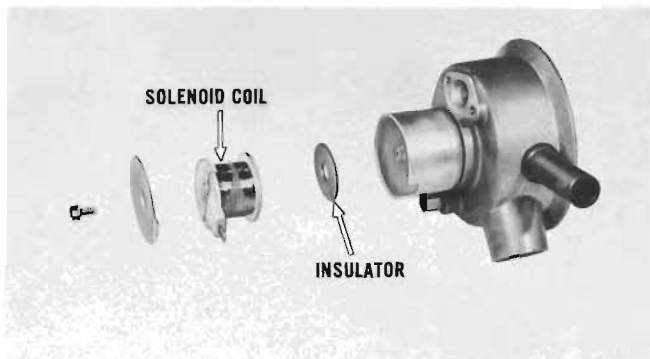

Remove solenoid coil cover screw and cover. Install new solenoid coil. Make sure insulator between solenoid and solenoid cup is in good condition.

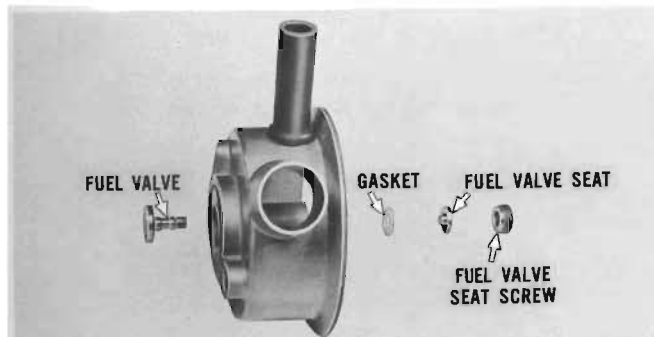

NOTE: It is not normally necessary to remove the fuel valve seat screw, valve seat and gasket from the burner housing. If these parts are removed for any reason, the fuel valve nylon gasket must be replaced.

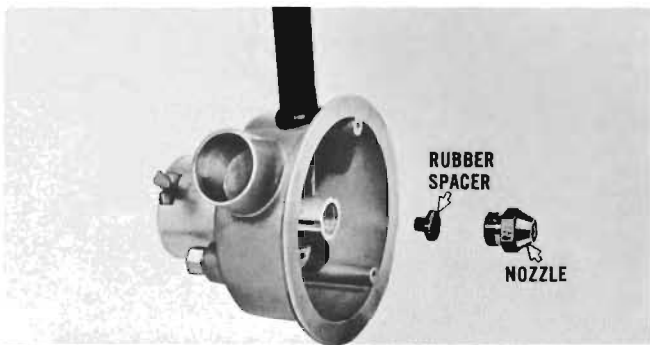

If the cause of fuel blockage is not due to an inoperative solenoid, all other components of the fuel section should be removed and inspected. Remove fuel nozzle and rubber spacer.

Inspect all parts and clean and replace as necessary. Do not blow compressed air through nozzle nor attempt to clean or remove nozzle screen. When installing nozzle, tighten to 100 inch-pounds (8 foot-pounds). Assemble all other parts following reverse of removal procedure.

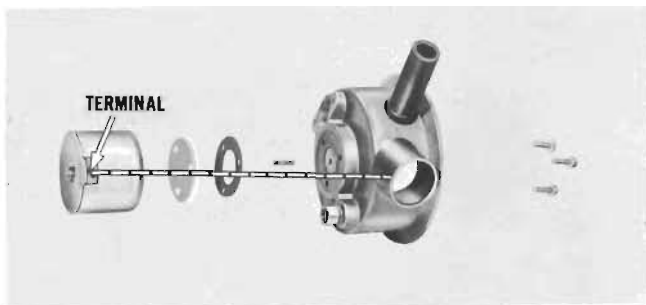

**NOTE:** When installing solenoid cup assembly, use a new gasket between sealing disc and burner housing. Make sure coil terminal is approximately in line with burner air inlet opening. Retest burner assembly for correct spray pattern and complete fuel shut-off.

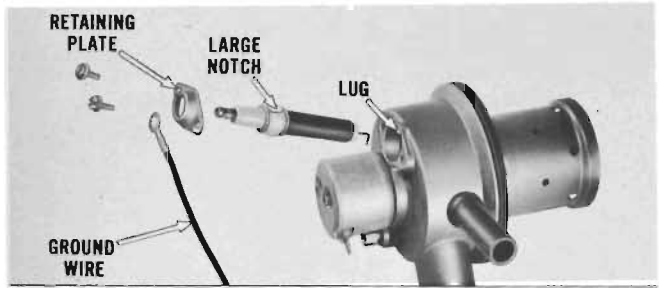

Install spark plug with gaskets and rubber sleeve in burner housing. The large notch in the spark plug porcelain indexes with a lug in the burner housing to provide correct electrode alignment. Ground wire should be installed between attaching screw and retaining plate as shown.

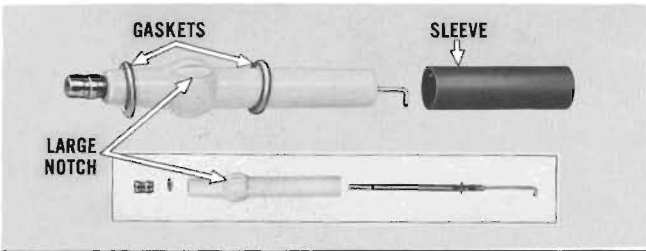

Before installing the spark plug remove the rubber sleeve and carefully inspect the porcelain for cracks. Inspect for badly burned electrode. If necessary, remove the electrode from the porcelain and clean electrode with emery cloth. When reassembling spark plug, the electrode should point away from the large notch in porcelain. Examine rubber sleeve and the two plug gaskets and replace if necessary.

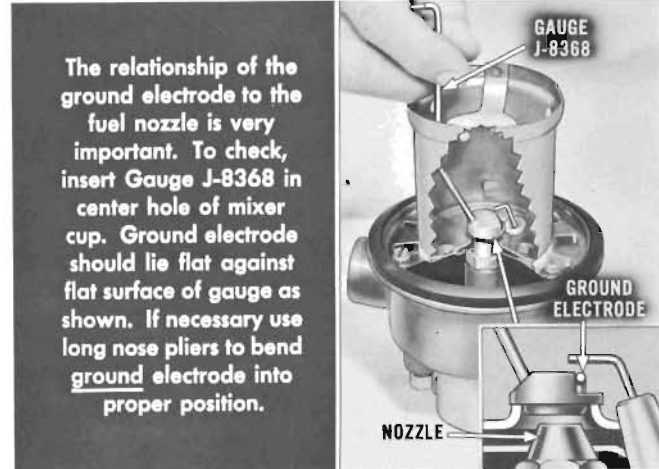

The relationship of the ground electrode to the fuel nozzle is very important. To check, insert Gauge J-8368 in center hole of mixer cup. Ground electrode should lie flat against flat surface of gauge as shown. If necessary use long nose pliers to bend ground electrode into proper position.

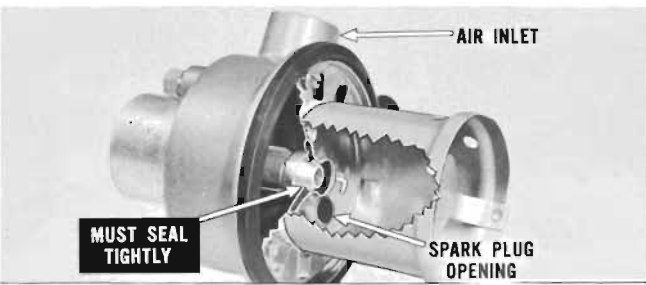

Install mixer cup and gasket, aligning spark plug openings in mixer cup and burner housing. The full circumference of the center opening in the mixer cup **MUST** seal firmly against the tapered end of the fuel nozzle. Check by looking through air inlet. There should be no light visible around nozzle.

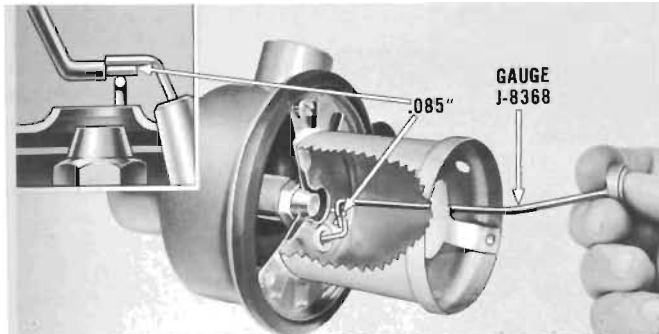

Use other end of Gauge J-8368 to check gap between electrodes. This end of gauge is .085" thick. Bend ground electrode only to adjust gap. Recheck alignment of ground electrode to fuel nozzle.

The stainless steel heat exchanger can be readily removed for inspection while the burner assembly is out of the heater case. If car age and/or heater usage warrants removal of the heat exchanger for inspection, proceed as follows:

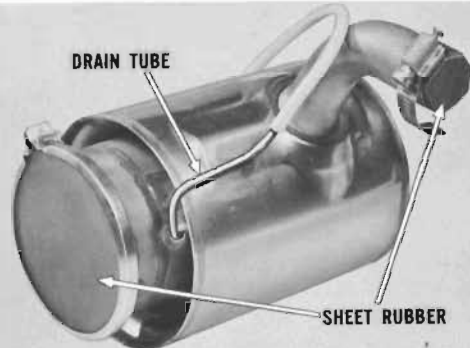

To test heat exchanger, block burner inlet and exhaust outlet openings with sheet rubber held in place with clamps. Connect rubber hose to drain tube.

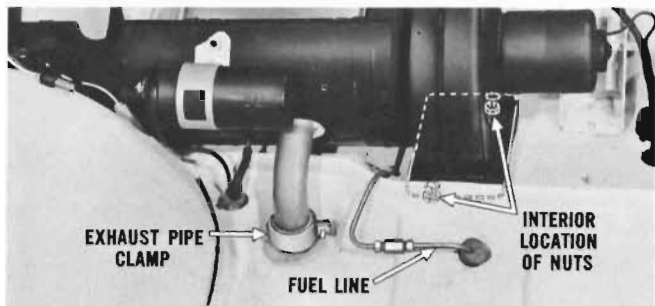

Disconnect exhaust pipe clamp and fuel line connections. To obtain clearance for removing heat exchanger remove two nuts holding ventilator blower case in place. (These two nuts are in the passenger compartment. One is located in the air distributor.)

Submerge unit under water and apply low pressure air to hose. There should be no surface leakage other than very tiny leaks from joints or welds. (Bubbles rising from joints or welds are permissible if they are no larger than "Champagne" size—about  $\frac{1}{32}$ ".)

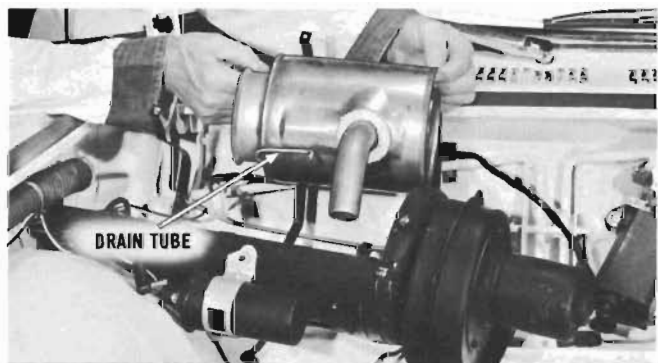

Disconnect the drain hose from the heat exchanger drain tube. Shift the lower heater case towards the front of the car. Remove heat exchanger.

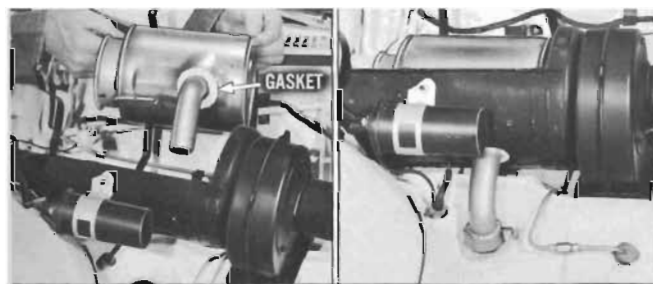

Install new or tested heat exchanger by fitting a new gasket over heat exchanger exhaust outlet, and install exchanger in heater case reversing the removal procedures. Make sure exhaust tube is fully in position on the heat exchanger outlet, and is properly seated. Securely tighten exhaust clamp and fuel lines.

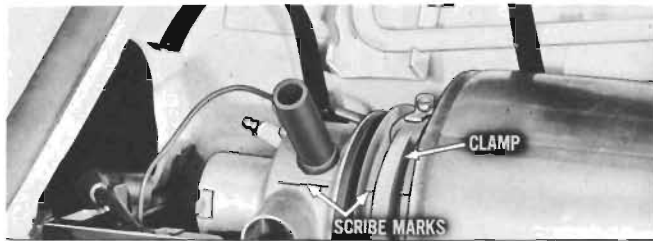

Install burner assembly so scribe marks on burner assembly and heat exchanger are aligned. Connect fuel line to burner housing fitting before installing retaining clamp. Tighten clamp securely. Before connecting fuel solenoid wire and installing upper half of heater case, start engine and check for fuel leaks. Complete the assembly of the heater following the removal procedure.

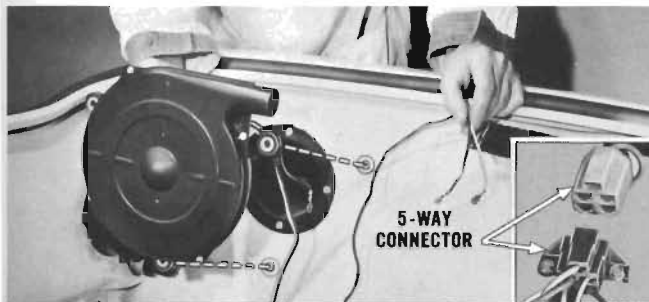

**COMBUSTION BLOWER:** Separate 5-way connector located on heater. Remove black and white wires leading to blower from the connector. Free these wires from clips. Disconnect outlet hose from blower. Remove the three attaching bolts and remove blower from car.

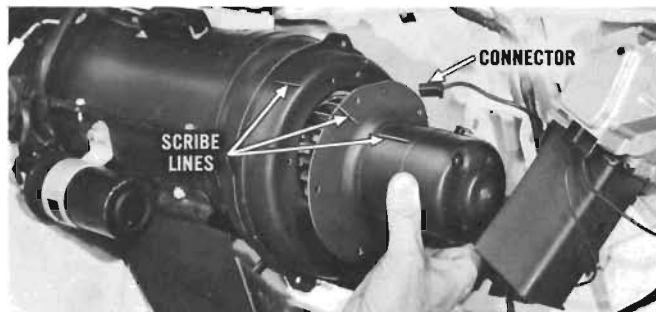

**VENTILATOR BLOWER:** To remove ventilator blower from heater, separate connector at motor terminal. Scribe a line across blower housing, motor mounting plate, and motor. Remove four retaining screws and remove motor and fan assembly.

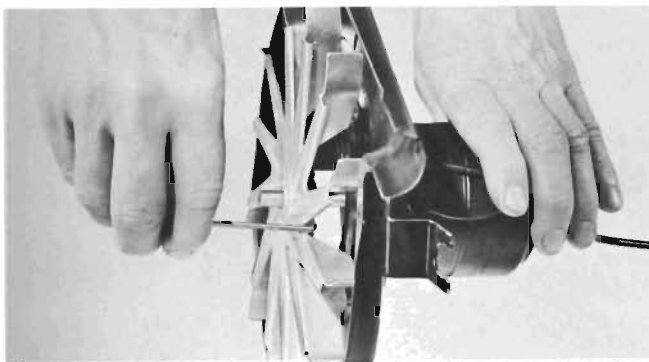

Remove ignition unit from end of motor as shown earlier. Remove outer half of blower case and loosen Allen head screw in inner side of fan hub. Pull fan off shaft.

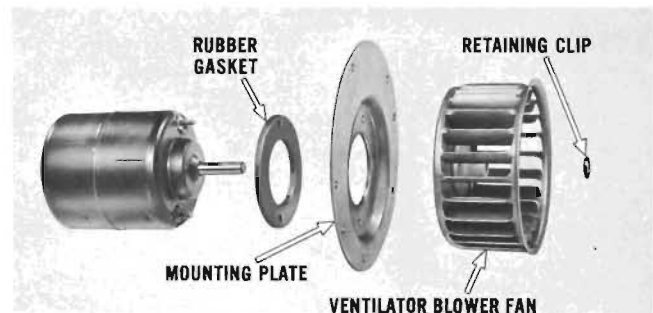

To remove fan, loosen retaining clip (or set screw) which ever is used. Install new blower motor or fan as required. Reverse procedures to assemble and install. (Use the alignment marks to assist in proper reassembly and installation.)

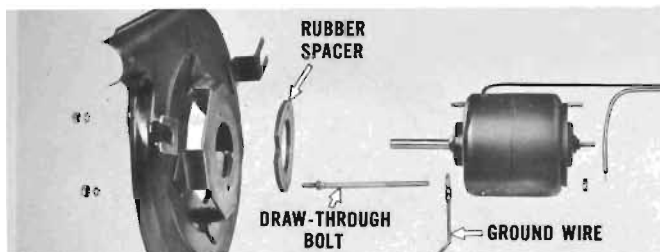

Remove the two nuts and lockwashers from the inner half of the blower case. Separate motor and rubber spacer. When reassembling, attach the ground wire between the draw-through bolt and the motor housing. **NOTE:** Replacement motors have two wires. The black wire leads into the motor case. The white wire is an extra ignition unit wire and should be discarded.

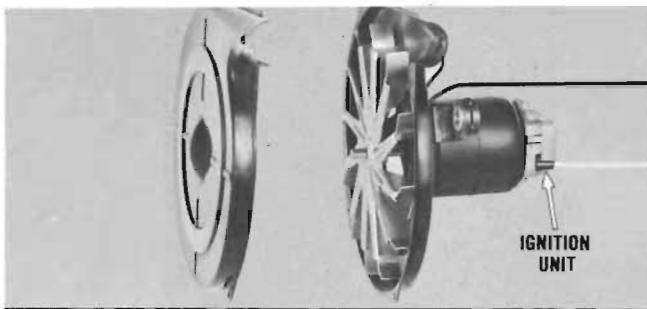

Locate fan on shaft so blades clear inner case. Tighten Allen screw. Attach outer half out of case to inner half. Install cam and primary ignition unit on end of motor. Check ignition point gap as shown earlier. Install blower assembly on car.

**NOTES**