

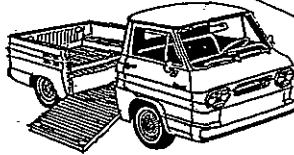

The Bi-Monthly Newsletter of Corvanatics  
The Forward Control Corvair People



Sportwagon  
Greenbrier



Pickups  
Rampside - Loadside



Van  
Corvan



Vol. 27, No. 1                      January-February, 1999

A Chartered Chapter of CORSA - Corvair Society of America

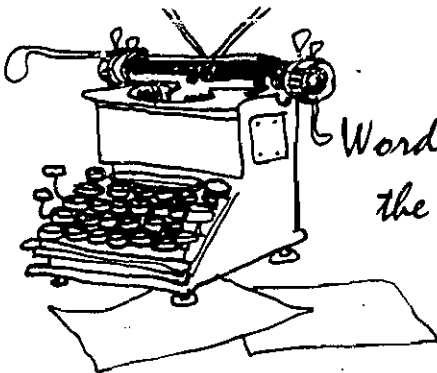

Words from  
the Editor

**Merry Christmas** to all the members of Corvanatics. As I sit here at my computer, looking forward to Christmas in Wisconsin we still have not had enough snow to make a Christmas. Last week I strung Christmas lights all around my Rampside and now have it parked in the yard for all to see and enjoy. I also made a lighted box sign which proudly displays the title "**Corvair 95**". I hope to be able to get some good pictures of it and perhaps submit that to the editor of *CorvanAntics* for insertion in an upcoming issue. Who knows!

It appears that this newsletter will be a little lean. But I am thankful for that, for that way I may be able to spend a little more time with my wife and family. I want to try to get this in the mail before Christmas; definitely before the first of January when the postage rates rise again. (I wonder what services they'll cut this time?)

As Diane has said elsewhere, it has been a good year for Corvanatics. In spite of some of the complaints about

the convention, most attendees enjoyed themselves and many of the things that people attend our annual conventions for were still enjoyed. And the membership has increased, which is the sign of a strong organization. I want also to thank those of you who have supported *CorvanAntics* with your articles. It makes this job a bit easier when there is something to print.

Because of the lack of articles for this issue I have gone into my "Archives" and pulled out a couple of things that, tho have not been written recently, are still of lasting interest to Corvanatics members. One article, written by retired GM employee Bob Kirkman, deals with FC springs. Another possibility is an old article on speedometer gears. Hope these add to your overall knowledge of your FC.

I want to get started laying out this issue so I won't drag this out any further. I do hope that this has been a good 'Vairin year for you and I especially hope that you all enjoy a **Blessed New Year**.

<b>In this issue . . .</b>	
Words from the Editor .....	1
Classifieds.....	2
Tech Topics:	
Rear Springs.....	2
Meet Your Directors:	
Fran Schmit.....	3
Jean Allan .....	4
Christmas Note from the Sectary/Treasurer .....	4
Corphibian .....	5

**PARTS FOR SALE:** Set of four shocks for FC, new after market, four for \$50. Early '61 distributor, needs rebuilding, complete, \$15. NORS set of upper and lower ball joints, in the box, uppers, \$30 ea.; lowers \$22.50 ea. Nice grill for FC, needs polishing, \$25. A '61 FC block date coded To106V relieved for long stroke crank, steam cleaned, ready to build, \$100. FC radio bezel and radio, nice, complete, radio needs work, I think radio is 1962, \$40. Nice rear air grill, ready to paint, \$75. Nice pair of original FC tail gate reflectors, \$35. Excellent engine deck cover with wires to hold insulation, \$75. (will not ship) Excellent set of 4 carb rotators with linkage and vacuum ports \$100. Set of 4, 13-inch Chevrolet beauty rims with black bow ties like new, believed to be for 60-61 cars, \$50. Early oil filter-generator adaptor with filter housing cut off and drilled, tapped to remote filter and pressure line, \$25. Pair of '61 carbs, with manual choke linkage, \$40. Bob Bauer, 6884 Providence Rd., House Springs, MO 63051-2115, (314) 671-0762.

**PARTS FOR SALE:** 1966 3:55 trans-axle, cleaned, painted, new seals, snout and some bearings, ready to install, \$125. Early model generator, rebuilt by Affton Auto Electric, cleaned, painted, \$65. Rebuilt starter, rebuilt by Affton Auto Electric, cleaned, painted, \$35. Four new shocks for FC, two front, two rear, \$15 ea. \$50 for set. Bob Bauer, 6884 Providence Rd., House Springs, MO 63051 (314) 671-0762.

**FOR SALE:** 1961 Shop Manual, \$20; 1962 Supplement, \$10; 1969 Supplement, \$25, like NOS. 2 turbo crossovers, both nice, one has partial linkage, \$10 ea. Early oil filter-generator adapter with filter housing cut off and drilled, tapped for remote filter, \$25. One 1960 aluminum 3-speed transmission in good shape, no leaks, \$150. Brand new, in the box, Auto Meter model 3700 tachometer, never used, cost new \$120, sell \$75. DUFF-NORTON 1-ton chain hoist with 20 ft of looped chain \$100. One pair of 62-63 80-hp carbs with tags, rebuildable, \$50. New Standard brand early voltage reg. in box \$25. Professionally rebuilt starter #1108306, \$40. Professionally rebuilt generator #1102226, \$75. No cores necessary, all plus shipping. Bob Bauer, 6884 Providence Rd., House Springs, MO 63051 (314) 671-0762.

**FOR SALE:** NOS Parts: 1 pr. 910487/8 FC Rear Lamp Assy., \$230/pr; 1 pr. 5950683/4 FC Clear Park Lamp Lens, \$10/pr; 1 pr. 5954443/4 FC Amber Park Lamp Lens, \$15/pr.; 3775631 FC Turn Signal Switch, \$20; 3776607 FC L.H. Front Door Lock Assy., \$20; 985900 '64 FC R.H. Sun Visor, \$20; 4-6255644 '61-'65 FC Head Lamp Bezel \$90 ea. Will part out '61 & '64 Vans, '63 Greenbrier & maybe a '64 Rampside. Maybe have what you need. John M. Mavity, 2177 Madison Ave., Indianapolis, IN 46225-1864, (317) 787-3091.

**FOR SALE:** Rampside walk-in camper, Very similar to the one in the last newsletter, Vol. 26, No. 3, page 6. Photo & video avail. \$8. ppd. Price \$200. Jim Craig, 7011 Sunny Vista Rd, Joshua Tree, CA 92252-2736. 760-9104.

## Tech Topics

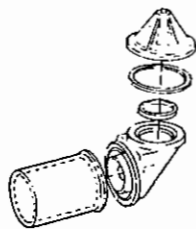

### Rear Springs

Corvaire 95 owners are cutting and substituting front and rear springs. Many, while they know what they *did*, do not know *what* they did. Sure, the springs have been cut and/or changed, but what did that do to ride height, spring rate, load, toe, camber?

Some years ago, then Corvanatics Technical Editor, Bob Kirkman, prepared an article for *CorvanAntics* in response to a member's question about excessive positive camber at the rear of a Corvaire. Bob wrote:

I went to the Chevrolet archives to see what I could find on original spring usage. Here are the part numbers and their corresponding specifications:

Continued on page 7.

## DISCOUNT CORVAIR PARTS

YOUR PARTS SUPPLIER FOR THE 90'S!



CORVAIR UNDERGROUND INC. HAS BEEN SERVING CORVAIR OWNERS FOR 23 YEARS! WE'RE HAPPY TO OFFER YOU DISCOUNT PRICING ON NEW, USED AND REPRODUCED PARTS AND SERVICES. CHECK OUT OUR BIG SELECTION AND ALWAYS MAKE SURE TO COMPARE BEFORE YOU BUY! WE GUARANTEE MOST PARTS FOR 1 YEAR AND WE HAVE A 30 DAY NO-RESTOCKING POLICY. WE ACCEPT ALL MAJOR CREDIT CARDS AND OFFER A TOLL-FREE ORDER MACHINE LINE FOR YOUR CONVENIENCE. CHECK OUT OUR FAST - SAME DAY SERVICE! FIND OUT WHY SO MANY BUY FROM THE UNDERGROUND

**CORVAIR UNDERGROUND INC.**  
**PO BOX 339 DUNDEE, OR 97115**

1-800-825-8247 24 HOURS 7 DAYS  
 1-503-434-1648 9-5 MON-FRI PST  
 1-503-434-1626 24 HOUR FAX  
 E MAIL [www.corvaireunderground.com](http://www.corvaireunderground.com)

## Know Your Directors

### Central Director Fran Schmit

Ray Mitchell has asked each of the directors to write a bit for the members. I suppose he wants us to become better known to ALL the members not just those who attend the National. Well, a little about myself. I have been a member of CORVAIR MN and CORSA for over twenty years and have been an officer/director in both organizations. I have owned more than a few FCs but right now have a '64 Greenbrier and a '61 Rampside. Both have what appears to be sunken rear springs so I run low profile tires on the front which takes them both "down in front". I also have a '64 Convert that had the same rear end drag--it was two inches low at the rear. I replaced those big hockey pucks that go between the Omega collar and the body--that alone brought the body up to level. I suspect that the rear-drag on a lot of FCs is from the same situation. As time goes by I will tell you what I find as I continue to enjoy my FCs.



Low profile front tires and homemade spoiler on FC

At the CORSA InterNational Convention in St. Louis I gave a little presentation at the Corvanatics meeting about a recent addition to the available FC hardware. This is a kit for a Dual Master Cylinder for the FC. The kit has a few unique parts which makes it very useable in the FC--parts that were made specifically for this FC application--parts that make a dual MC fit perfectly into your favorite Corvaire. The kit is available from the Source in Del Mar, CA. I helped the vendor develop this kit because I felt there was a need for it. The alternative was to use a Corvaire car dual MC and then bash the frame of the FC until it fit. I did that on my Greenbrier and it looks really horrible under there now and I wanted a better design to tell people about. Many people asked me about a dual master cylinder and

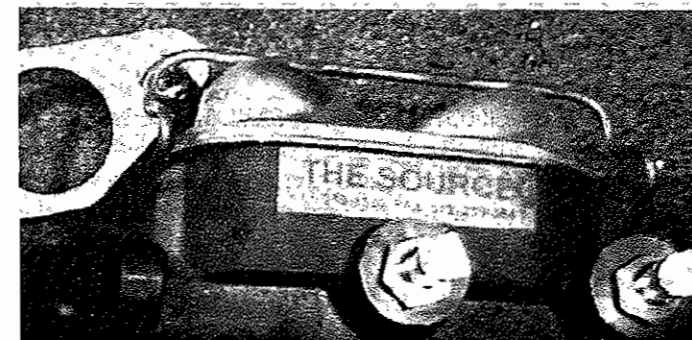

FCDMC (FC Dual Master Cylinder)

all I could tell them was the "bashing" story--that gets old real fast. I was working with this vendor on the fuel pump controversy for a couple years so I got to know him and understand that he is a highly opinionated person interested in providing quality products. To go along with this very nice MC (I like to call it a FCDMC, for Forward Control Dual Master Cylinder) he offers Kelvar-lined brake shoes and stainless steel braided Teflon-core brake hoses--so when you redo your FC brakes with parts from The SOURCE you will have GOOD brakes.

A few months ago I was ordering something from Harbor Freight and they had a pair of very long screwdrivers--like two feet long, each. I bought them and then wondered what I was going to do with them. The other day I was doing some carb work on the Rampside. You all know how hard that is on your chest as you have to lean over the tailgate to do anything. I have actually bruised myself working there. Well, to make a long story a little shorter, these two screwdrivers, (flat and Phillips) are ideal for working on the Rampside's carbs as they reach way down into the bed without having to bend down. Look



Fran Schmit demonstrating 2-foot screwdriver for Rampside carb work.

them up; I'd say I paid about \$5/pair--there's a number on the pouch they came in, P-34253. Somebody could buy a bunch and them sell them in the *CorvanAntics*! A little side note: One of my sons works for a British company and they refer to the two screwdrivers, the standard flat and the Phillips, on how they look on the end--plus and minus. I think that is an excellent idea and one well worth copying.

Speaking of copying, many modern vehicles have spoilers, I am also driving my GB with a homemade spoiler under the front bumper that seems to take away almost all of the 18-wheeler's sideways push. I say 'almost' as my recent trip with Corvaire Minnesota to Mt. Horeb, WI, our annual Fall Run to see the color change (this year of El Nino everything was still green, but the area was well worth the 13-car visit) was run in our 'spoilered' GB'. Yes, I can still feel them when they go by, first a gentle nudge toward the right and then, as the 18th wheel goes by, the suction from behind takes hold and the nose of the GB is tugged toward the center line. It used to be scary, but now is only noticeable. So, good news! You really don't have to dart back and forth when the BIG guys

Continued on page 6.

## Christmas Note from the Secretary

I hope everyone had a Merry Christmas and a Happy New Year, just enough snow for those in snow country, and sun in the sun country.

This was a very good year for Corvanatics as those of you who were at St. Louis know, and the rest learned from the newsletter. Thanks to all of the members who make this club what it is, from our esteemed President to the newest member, we all count.

Check out Mike Kellstrand's web page for us. Well done, and gets us quite a few new members.

And please give David Hartmann a BIG round of applause for the untiring work he does on the newsletter ... Applause, applause.

I would like to say a big "thank you" to all the support I get as secretary/treasurer. Thanks everyone. Especially to my husband, Bob, who puts in more time than I do. Thanks, Honey.

*Diane Galli*

Secretary/Treasurer

"Humble people don't think less of themselves--they just think about themselves less." -Unknown



## SOUTHWEST CORVAIR

- Quality used parts, rust-free from Arizona
- We buy used parts--complete garage buyouts are our specialty!!
- Order our NEW Fully Illustrated Catalog with over 4000 used parts listed! Send \$3.00 to:



32 E. Raymond Street  
Phoenix AZ 85040  
(602) 268-5968

24-hour machine  
(602) 268-8214

Monday thru Friday  
9:00 am - 5:00 pm

Visit our web site at:  
[www.southwestcorvair.com](http://www.southwestcorvair.com)

## Meet the Directors

### Jean Allan, Director-at-Large

Those of you who were present at the Corvanatics meeting in Collinsville may remember that when I was nominated for the director-at large position, I asked what a director-at-large does. The unanimous chorus from the attendees was: "Nothing". So I said I could do that. But somehow I now hear from Ray Mitchell that he wants the directors to write something for the newsletter. So here goes "Nothing".

I can't say I've done a whole lot with my FCs since the convention other than drive around. Since getting the red Greenbrier well washed at Collinsville, I haven't put too many miles on it. In late fall its brakes began to pull to the left and I put it away with a note to myself to solve this problem in the spring. I'm still looking for a red mat for the engine lid for this Greenbrier (and all the floor mats, if I'm permitted to dream)--just in case anyone knows where I can get those. Meanwhile, I have been driving the green Greenbrier more (this is the one with the prototype folding rear seat).

Which reminds me: the green Greenbrier did strand me last summer. I shouldn't tell this story, because I felt really stupid during the whole process, but I will. A mile or two from home one day, I heard a few plinking noises in the engine. Nothing else happened and the engine sounds didn't change, so I continued toward home. Pretty soon, I began to smell burning rubber, so I pulled into a parking lot a few blocks from home to check it out. Ah, yes, the fan belt had self-destructed. I can't fix that. So rather than just drive it home, I walked home for a fan belt (I always do carry one, but I thought I'd put on a newer one than was in the van) and wrench so I wouldn't have to smell that rubber. I hadn't determined just why I was smelling rubber at that point, so I figured a ten-minute job.

Back at the Greenbrier, driving the '64 convertible, I found I wasn't going to just whip that new belt on there. The old belt had shredded itself, lost big chunks, and had jumped the pulley and wedged itself there. The outer fibers of the belt were still holding together and had pulled until an intact section of belt got wedged between the pulley and the engine. This thicker section then apparently got firmly stuck and ceased to move, explaining the burning rubber smell. Try as I might, I couldn't get that stuck piece of belt out from behind the pulley. Not in either direction, not downward, no way. I was reluctant to cut the belt, as I thought I needed it's length to give me something to pull on. Anyway, I didn't have anything with me for cutting.

After struggling for quite a while, I gave up and drove home for some other tools and a knife. Back at the scene of the crime, I finally did have to cut the belt leaving a long piece on both sides for pulling. When I still couldn't get it out, I finally cut off all I could next to the back of the pulley and decided to drive it home, so I could work further on getting that last 6 or 8 inches of rubber out of there. At this point it was clear that I should have driven it home in the first place, but this was two hours later and hindsight is 20/20. Of course, to take it home, I first had to drive the

Continued on page 5.

Jean Allan continued from page 4.

convertible home and then walk back to drive the Greenbrier home.

When the tools were loaded up and both vehicles still there, a guy drove up and asked how much my Corvair was worth. Not getting an appropriate response when I asked, "Which one?" I figured this is not a Corvair person and he's talking about the convertible: "Maybe \$5,000." I said, not wanting to sell it. "Bout what I'd think they're worth," he said. "Used to have one like that." And he drove off. Such was the only crumb of interest anyone showed in this entire procedure in a strip mall parking lot.

I now have the new fan belt installed, but have not

solved the problem of the piece of belt between the pulley and the engine. No more hot rubber smells, so maybe it's found a home in there. Or maybe it's been thrown out. Don't know. Don't care, as long as nothing else goes wrong.

All of this was in lieu of writing something intelligent for the club. Like keep supporting CPF, keep driving your FCs, keep writing those tech articles (I really do appreciate those), and start making plans for Tahoe (we should all start as early as Pete Koehler, and we all need to be there to see if he makes it). And have a wonderful New Year!

*Jean Allan*

## EVERY MOMENT IS PLEASURE WITH CORPHIBIAN

### CORPHIBIAN AN EXCITING NEW DIMENSION IN MOTORING



This is Corphibian's basic model... ideal for fishing, hunting, swimming, skin diving or just cruising around the lake. It's easy to drive... easy to park. It's compact, light-weight and thrifty on gas. Corphibian is at home on land or lake... truly the universal vehicle.



#### Family Size Sedan Cabin

Roomy five passenger cruiser is a family delight! Corphibian is the perfect vacation vehicle with room for mother, dad, and children. Corphibian is a safe, seaworthy, roadable family traveler.



#### Sportsman's Convertible Top

Optional deck seats and this rugged vinyl coated fabric top make Corphibian the perfect day cruiser. All the fun without the expense... no seasonal preparation or conditioning. When the boating season's over there's no storage problem with Corphibian.



For the real outdoorsman a dream come true. This optional off-the-ground tent camper makes your Corphibian a rolling motel.

Always ready to go over highway or waterway! Corphibian is a rugged all purpose vehicle, watertight and seaworthy. On a lake or a stream it's a sportsman's dream!

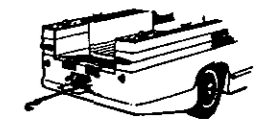

Optional equipment includes and under-the-tailgate winch which makes Corphibian a rugged utility vehicle afloat or ashore.

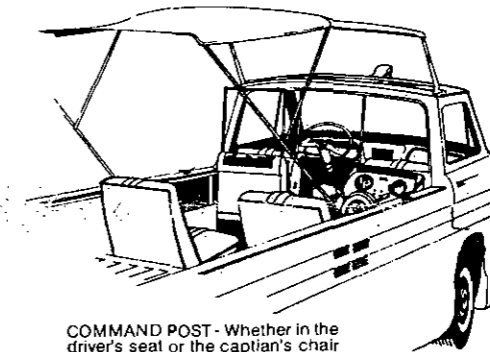

COMMAND POST - Whether in the driver's seat or the captain's chair the outdoor world is at your command with Corphibian. Just take the wheel and follow your imagination!



Diving board and boarding ladder, available as optional extras, gives the Corphibian unique versatility for water-sports.

## CORPHIBIAN EQUIPMENT AND SPECIFICATIONS

Corphibian is not in production. The interest of manufacturers is being solicited. Vehicle, equipment and conversion manufacturers interested in Corphibian contact Hulten-Holm and Company.

#### Standard Equipment

Heater  
Dual Exhausts  
Dual Marine Controls  
Twin 10" Propellers  
No-Rust Fiberglass Hull  
Full Foam Floatation  
Goodyear Safeguard Safety Spare Tires  
Two-tone Paint  
95 Horsepower 6 Cylinder Air Cooled Engine

#### Optional Equipment

Automatic Transmission  
Radio  
Five Passenger Cabin  
Flying Bridge  
White-wall Tires  
Power Operated Winch  
Electric Shift Propellers  
Limited Slip Differential  
Tonneau Cover

#### Specifications

Length..... 195 inches	Ground Clearance... 7 inches	Highway Cruising Speed... 70 mph
Width..... 70 inches	Draft..... 9 inches	Marine Cruising Speed... 12 mph
Curb Weight..... 3200 lbs.	Load Draft Ratio... 500 lb/in.	

Conceived and Designed by:

**HULTEN-HOLM & Co.**  
523 Tilmor Drive, Pontiac, Michigan

All information, illustrations and specifications contained in this literature are based on the prototype vehicle and design. The right is reserved to make changes at any time without notice in materials, equipment, specifications and models, and also to discontinue models. HULTEN-HOLM and COMPANY.

*Corphibian*



Hulten-Holm & Co., 1963

CORSA COMMUNIQUE/December 1981

**Fran Schmit** continued from page 3  
 come at you anymore. Since I found that I could modify the spoiler from an S-10 to fit my convert--I was told it would fit directly onto an FC. Very incorrect story, as it's nearly a foot too short. I am working with The SOURCE again on a spoiler for the FC that will actually be made to really fit right on and also look professionally made. Mine is obviously homemade and 'works better than it looks'. There's this joke about a farmer who sells a horse to a guy with the admonition that it "doesn't look so good". Later the fellow angrily brings the horse back saying the horse is blind in one eye and the farmer says, "I told you it didn't look so good".

Another FC project that I am working on is the three-point seat belt for a GB. Obviously the seat belts are available from hundreds of different old cars. Chevrolet Caprice belts are my choice, but they will all work once the high mount point is designed. I have not yet installed them in the Greenbrier. The Rampside was a "no brainer", so I've had them in there for years. Jeff Angelli is a fellow GB'er whom I have met on Virtual Vairs, he wrote some notes in the newsletter about "Use2bjunk", remember? He has built a roll bar into his GB and used it to mount his high point. Neat idea! However, I'm afraid that most FCers



Jeff Angelli's roll bar/3-point seat belt mount.

will not want to install a roll bar, for whatever reason. I have saved a section of the doorpost from a cutoff 8-door that a friend of mine was parting out. This piece of iron is rolling around in my head as I try to think of the best way to mount/anchor that high point. I have seen some very bad examples of how not to do it at some Corvair conventions. I won't even repeat what I saw for fear that

someone might claim that I suggested it; on the other hand I feel there is some degree of responsibility in being a Corvanatics Director such that I should have some verrrry solid reasoning going behind any suggestions of where/how to mount the belt. Maybe I will put together some of my various efforts in a future note and have y'all pick on them and suggest a best fit.

Two other things for the FC that I'm working on are the windshield washer bag--a reasonable way to refill it(?) and the taillights. The tail lights are so wimpy (on cars too, but in them I simply replace the back-up lights with another set of taillights and the rearend becomes much more visible. The FCs are a real problem, as most of us don't want to cut a hole in the door to replace the reflector panel area with another light unit. I've seen it done very nicely. So what I have had in mind for a few years now (right, Charlie West?) is a scheme for adding two sets of LEDs into the red plastic lens of the FC. One set would be on with the running lamp and the other set would be placed in the shape of an arrowhead and would come on with the

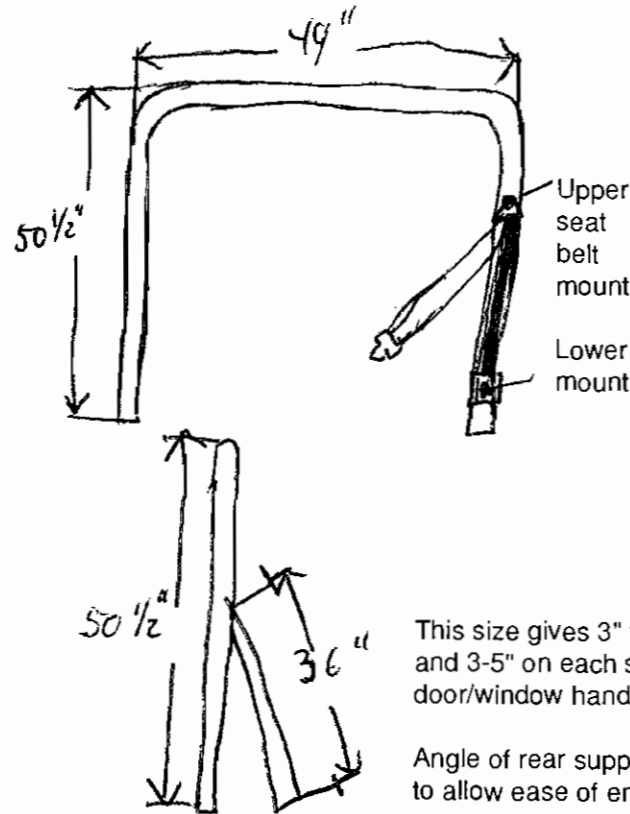

signal lamp. The idea is basically a simple one, but putting it together so that anyone could readily mount it in their FC--that takes some ergonomical engineering.

For now, it seems that you should have a little bit better idea 'who is the Central Division Director?' Oh yeah, my name is--- *Fran Schmit*.

"You can either complain that rose bushes have thorns, or you can rejoice that thorn bushes have roses." -Unknown

"It is no longer politically correct to call someone 'bald'. The correct term is 'person of scalp'. -Unknown"

**Tech Topics: Springs** continued from page 2

Rear Spring	Year(s)	Model(s)	Rate	Checking Load	Free Length	Wire Dia.	Total Coils	Production I.D. Tag
3775098	1961 start	all	580	1922	12.22	.660	7 <sup>15</sup> / <sub>16</sub>	none
3798434	1961 interim, also 62	all	750	2093	11.66	.710	7 <sup>15</sup> / <sub>16</sub>	none
3829556	1963-64 1963 start	pickups Greenbrier and panel	1230	2068	10.54	.775	6 <sup>3</sup> / <sub>4</sub>	"R-10"
3848586	1963 late, also 64-65	Greenbrier and panel	1230	2658	11.04	.775	6 <sup>3</sup> / <sub>4</sub>	"R-10"

Service springs had tags with part numbers. Production springs by drawing specs had nothing or just a tag reading "R-10". Therefore it is tough to know what is really in the vehicle without doing some measuring.

Checking Load has nothing really to do with vehicle rear axle load. It's only the load the spring should produce when compressed in the checking fixture to a length of 8.81 inches. You have to have some numbers, suspension factors and vehicle weight to figure how tall it should sit.

Vehicle ride balance (how it floats, bobs, pitches, and follows the road) is largely a function of the front and rear suspension rates and the weights they carry. The FC series "liked" high rate rear springs.

1961 interim spring change was made to improve "flatness of ride" on all models and trim height on pickups. Rear end was raised slightly

A height "A" or "D" was referenced for curb weight (vehicle has been driven forward or reverse) that was from centerline of the rear suspension control arm shaft (bolted to the crossmember) to the ground. 1961 specs were:

Vehicle	Curb Dimension	Curb Camber
Greenbrier	13.35	+3°36'
Corvan	13.88	+4°8'
Pickup	14.28	+5°12'

These numbers must have been a guide, as no mention is made of any type of equipment (third seat, deluxe trim, heater, flat floor, etc.)

For 1963, the spring rate jumped way up and the spring specs were such in relation to curb weight that the rear end was significantly lowered. This new spring plus six- and eight-ply tires were released "to correct field complaints of excessive tire wear...". Additionally a spring spacer (p/n 3829551 at .44-inch thick) was created for service use only. I can only imagine that it was for use on continually loaded vehicles where the rear end would otherwise now have negative camber. 1963 specs were:

Vehicle	Curb Dimension	Curb Camber
Greenbrier	12.74	+1°29'
Corvan	12.95	+1°58'
Pickup	13.25	+2°42'

Engineering "caught it" from management because of a tail-drag appearance on deluxe Greenbriers. Service was upset because the rear bumper was too low to

provide much protection from the rear. Therefore, very late in 1963 production, another, taller spring was released for Greenbriers and Corvans. It bumped dimensions back up:

Vehicle	Curb Dimension
Greenbrier	13.92
Corvan	14.09

Curb Camber numbers were removed from the records in 1964-65 for assembly plants, since camber was always non-adjustable, just a byproduct of what the springs gave. 1964-65 ran out with the same spring usage as that late 1963 change.

Judging from all figures, the Corvan should have run its life with rear camber somewhere from a bit less than +2° to a bit more than +4 1/2°. So how can someone have a camber measurement greater than that? And if it really is a bunch more than +4 1/2°, what can be done?

1. Never evaluate camber after the vehicle has been jacked up and set down. Always roll it forward or backward to let the suspension "straighten out".
2. Springs may be mispositioned in the seats; that is, rotated in the seats until one end sits up on the seat helix end. Spring should be giving evidence of this by noise, pop, rub.
3. Someone put a spring spacer under the spring of their Greenbrier, and later switched the suspension to a Corvan.
4. Springs not made for an FC have been substituted.
5. ????????

The figures would tend to indicate the use of the pickup spring #3829556 (no longer available through GM) will knock the camber down by 2°, and the use of the early spring #3798434 (also no longer available) would give about 2 1/2° less camber, both with respect to spring #3848586.

Cutting a bit off a coil won't help. You have to cut off one full coil and that's much, much to much effect.

"Torching" a coil will get you down, but the heat treatment is all shot in the heat transition zone. This would really require re-heat treating the whole coil.

My information is from the archives for assembly plant information. Other publications *should* be based on this assembly plant information, but there are inconsistencies. In some publications, all FC vehicles appear to be lumped together with an averaged figure!

**corvair**

N.O.S PARTS  
USED PARTS

*Jim's Corvair Shop*

QUALITY CORVAIR REPAIRS

2826 MEMORIAL DRIVE  
TWO RIVERS, WISCONSIN 54241

JIM JIMENEZ  
920-793-1982

1120344-0-0

**CORVANATICS OFFICERS & DIRECTORS**  
for 1998 - 1999  
PRESIDENT

Ray Mitchell, 740/862-3711

P.O. Box 328854, Columbus, OH 43232

VICE-PRESIDENT

Dennis Pleau, dpleau@gte.net

120 Camino de Amador, Albuquerque, NM 87107

SECRETARY-TREASURER

Diane Galli, 805/466-2737, rdgalli@tcsn.net

5000 Cascabel Rd., Atascadero, CA 93422-2302

DIRECTORS

Eastern: Tim Schwartz, 201/447-4299, toschwartz@world-net.att.net, 5 Riverview Lane, Ho-Ho-Kus, NJ 07423

Central: Fran Schmit, 612/929-9174, schmfra@juno.com  
3370 Library Lane, St. Louis Park, MN 55426-4224

Western: Lon Wall, lonwall@corvairunderground.com

P.O. Box 339, Dundee, OR 97115

At Large: Jean Allan, 317/784-6727

50 N. Main St., Southport, IN 46227-5136

TECHNICAL EDITOR

Jim Jimenez, 920/793-1982

2826 Memorial Drive, Two Rivers, WI 54241

HISTORIAN

Dave Newell, 415/223-4725

P.O. Box 588, Olinda, CA 94563

EDITOR

David Hartmann, 920/892-6511, dahartmann@mail.tcbi.com

1111 Evergreen Road, Plymouth, WI 53073-4110

FOUNDER

Ken Wilhite

9560 Maple Way, Indianapolis, IN 46263

CORVANATICS is the bi-monthly publication of Corvanatics, a Chartered Chapter of the Corvair Society of America (CORSA). Established September, 1972, Corvanatics is dedicated to preserving and enjoying America's original and most innovative small vans and light trucks, the Chevrolet Corvair 95 Series.

Membership in Corvanatics is open to any CORSA member with an interest in Forward Control Corvairs. Membership applications are available from the Secretary/Treasurer, Diane Galli, 5000 Cascabel Road, Atascadero, CA 93422-2302.

Dues are \$6.00 per year and must be sent to Diane Galli. Sending them to another address will only slow your renewal and possibly cause you to miss an issue. Club Window Stickers are \$1.00 each and Jacket Patches are \$2.15. Club Stationery is 5¢ each sheet, rosters are \$2.00. These are available from Diane Galli only, as are Membership Applications.

**Stories, articles, photos or anything of interest to Corvanatics Members should be sent to the editor: David A. Hartmann, 1111 Evergreen Road, Plymouth, WI 53073-4110. Technical material should be sent to the Technical Editor.**

Classified ads are free to Corvanatics members and should be sent to the Editor. Display advertising is also available at the following rates: Full page: \$25; Half page: \$15; Quarter page: \$10; Business Card (2x3.5) \$5. Please submit print-ready or typed copy and pre-payment to the editor. Photos for ads (black & white, if possible) are \$6 each. Authorization and payment must be received for each issue. Deadline for publication is the 15th of February, April, June, August, October or December.

Web Page address: <http://www.ziplink.net/users/mak/corvanatics>

**CORVANANTICS**

5000 Cascabel Road  
Atascadero, CA 93422-2302



**FIRST CLASS**

7-99  
729

32791



**CORVANATICS**

**THE FORWARD CONTROL CORVAIR PEOPLE**